



HAPPIESTCAMPER.COM

Size Key Chart

Small

Medium

Large



2 x 2 inch
Test
Square



2



3

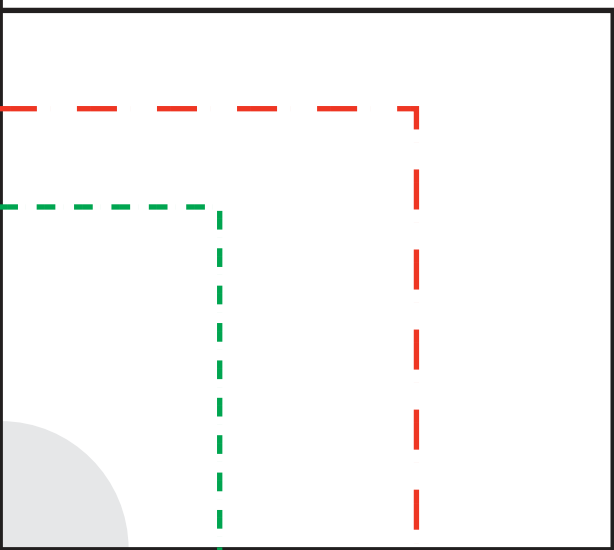

4

5



HAPPIESTCAMPER.COM

Kimono
Front

Cut 2 mirrored

3/8" seam allowance already included

Grainline

Direction of Stretch



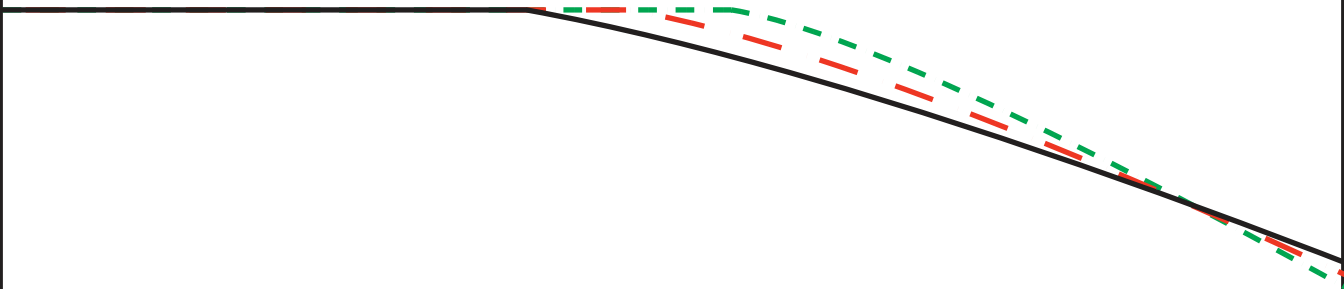

7

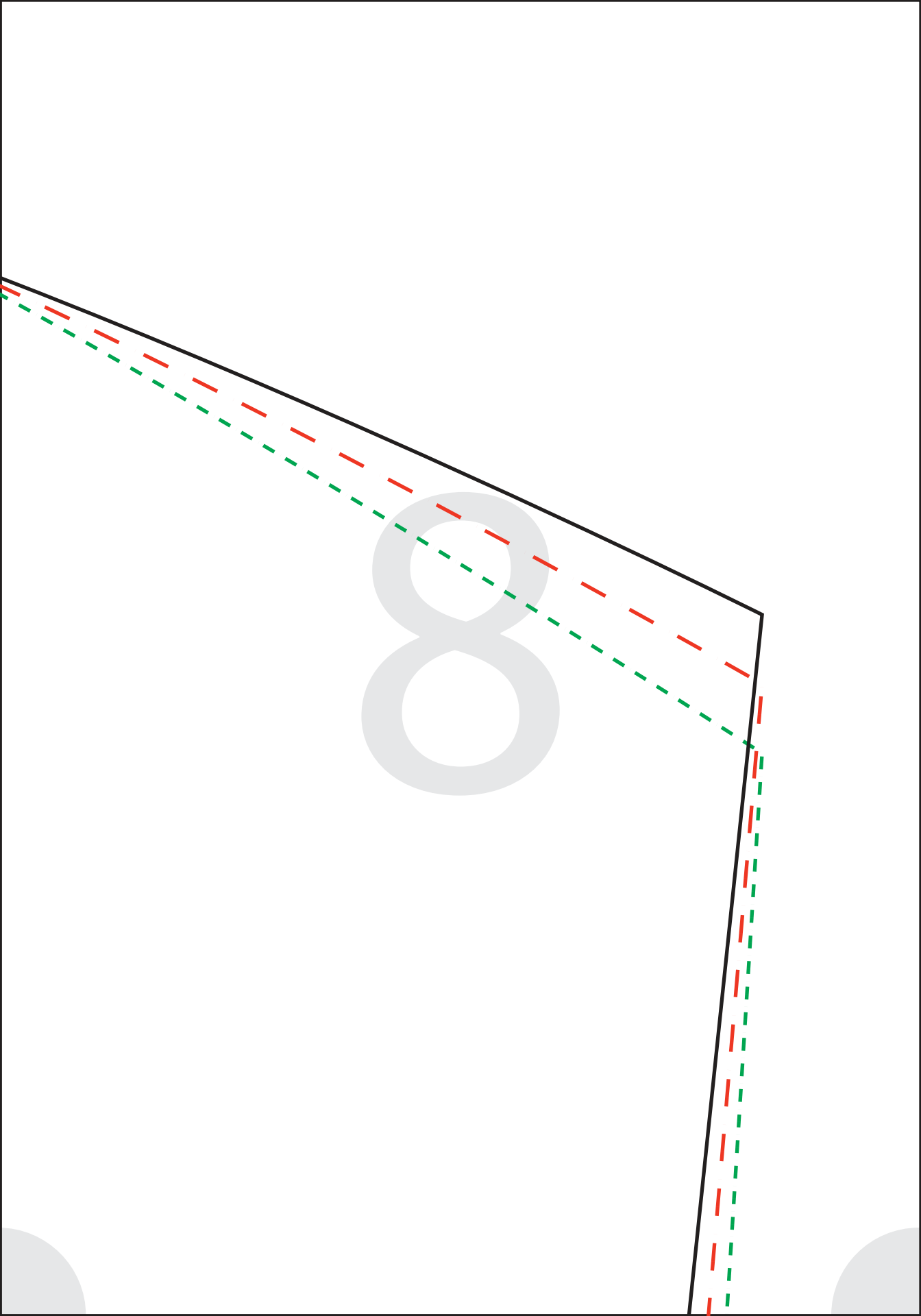

9



10

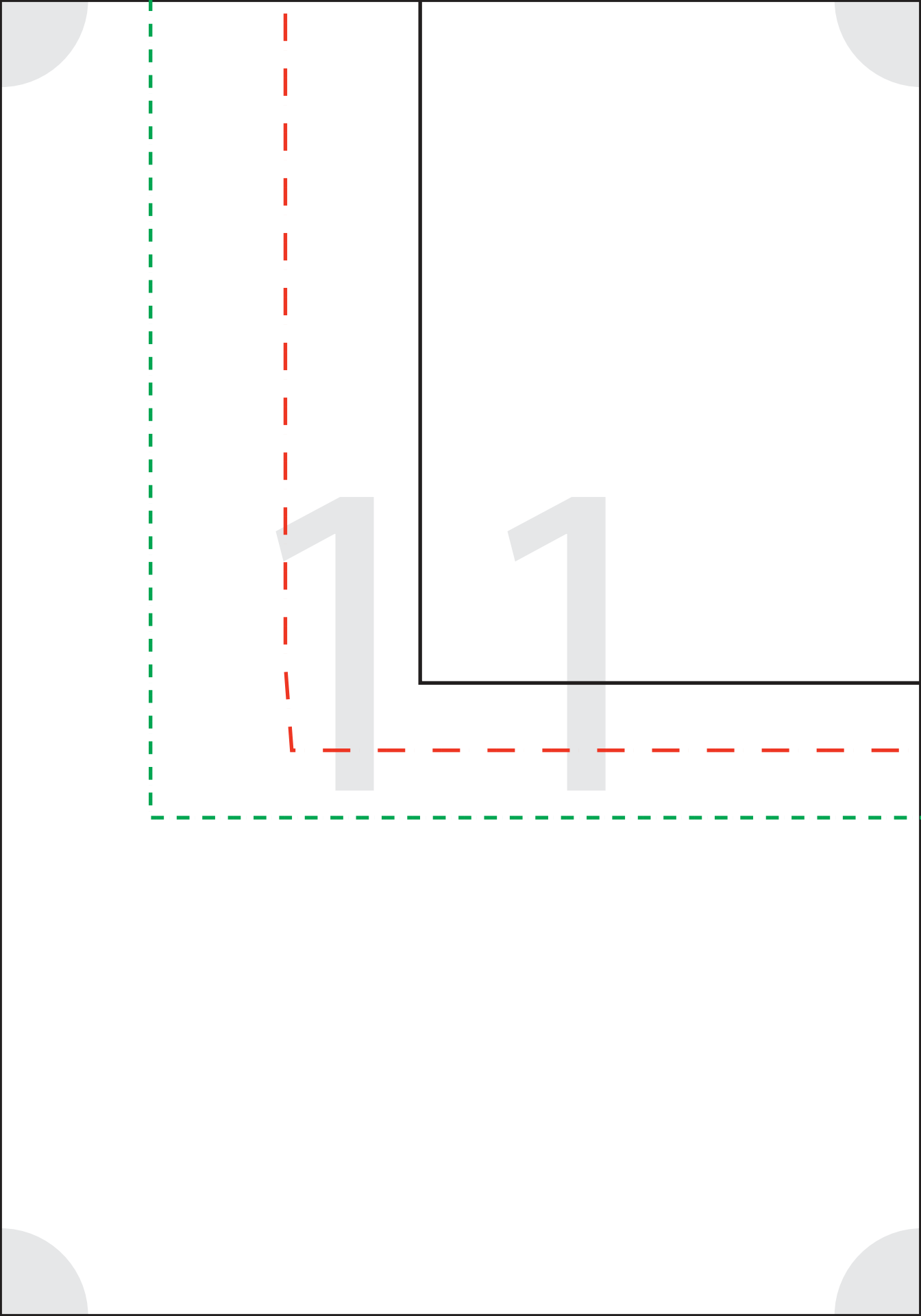

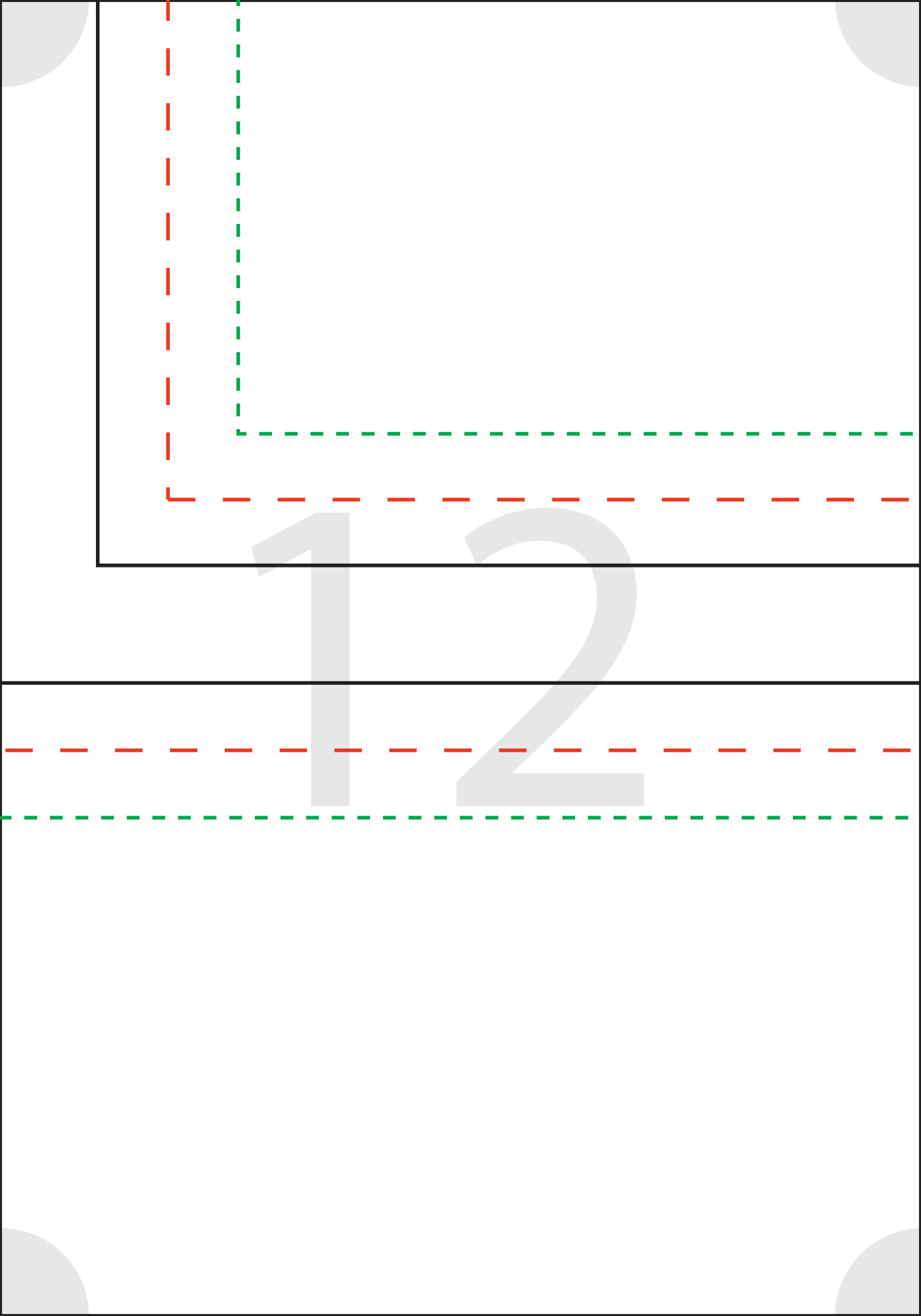

1 2

13

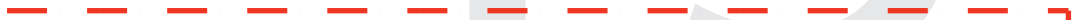

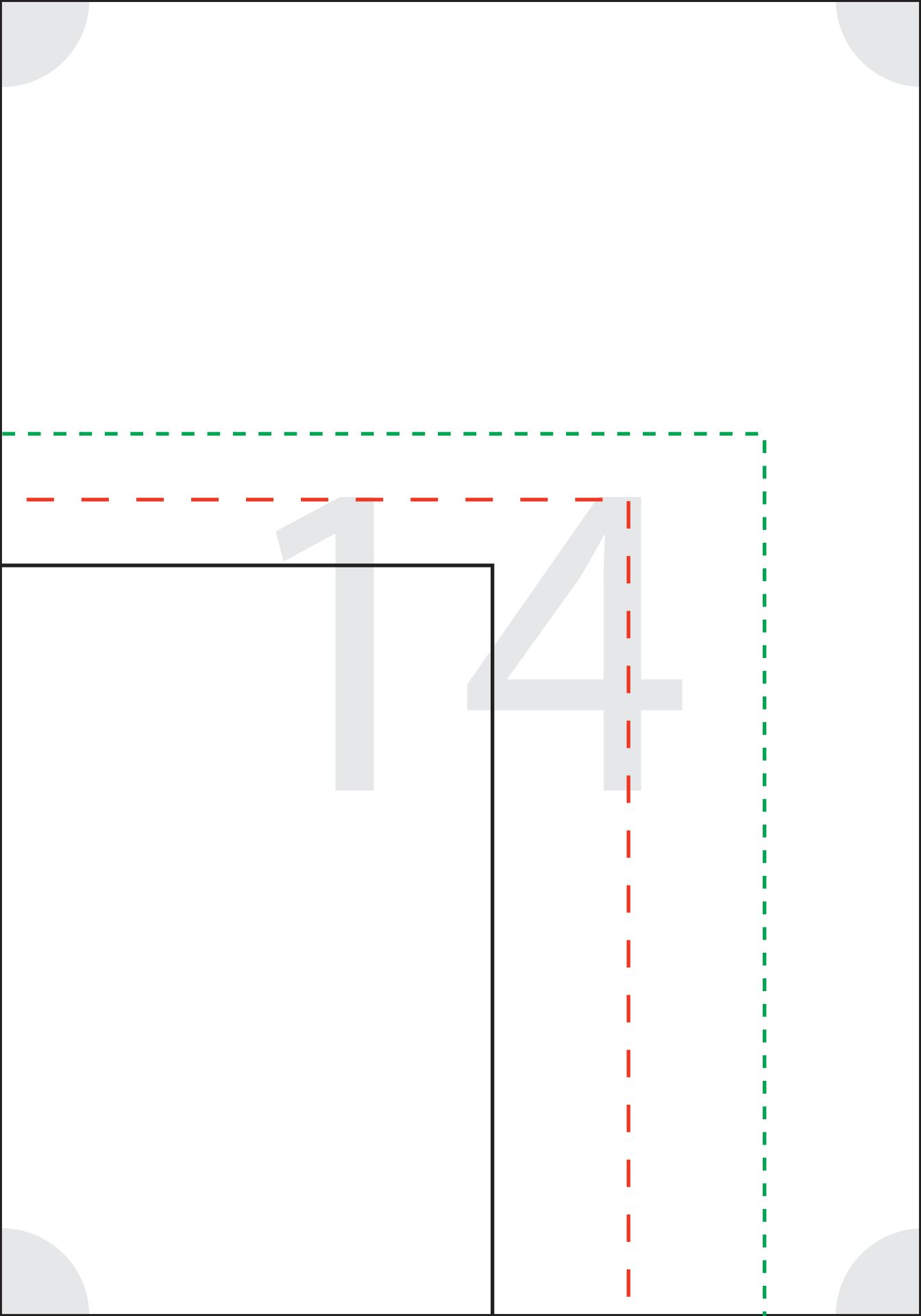

14

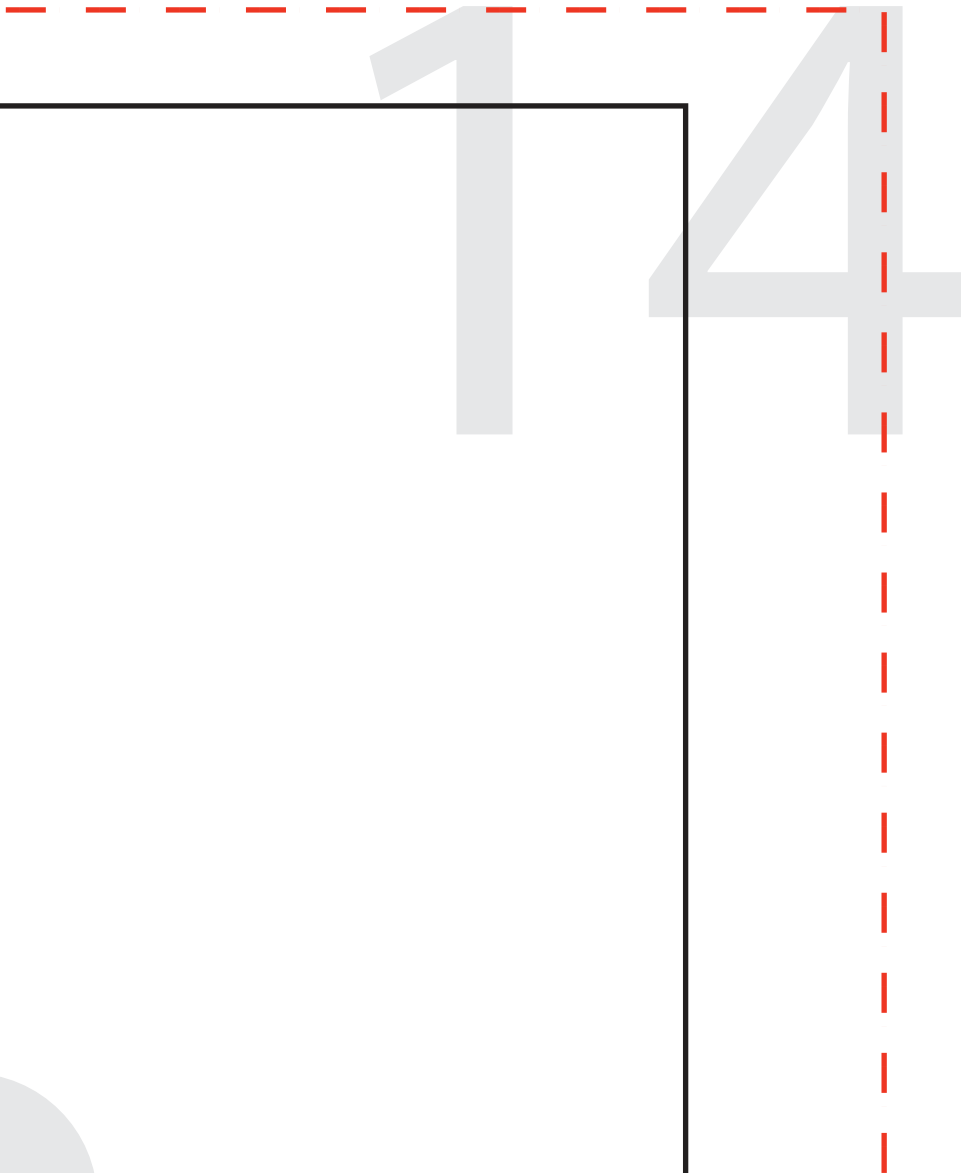
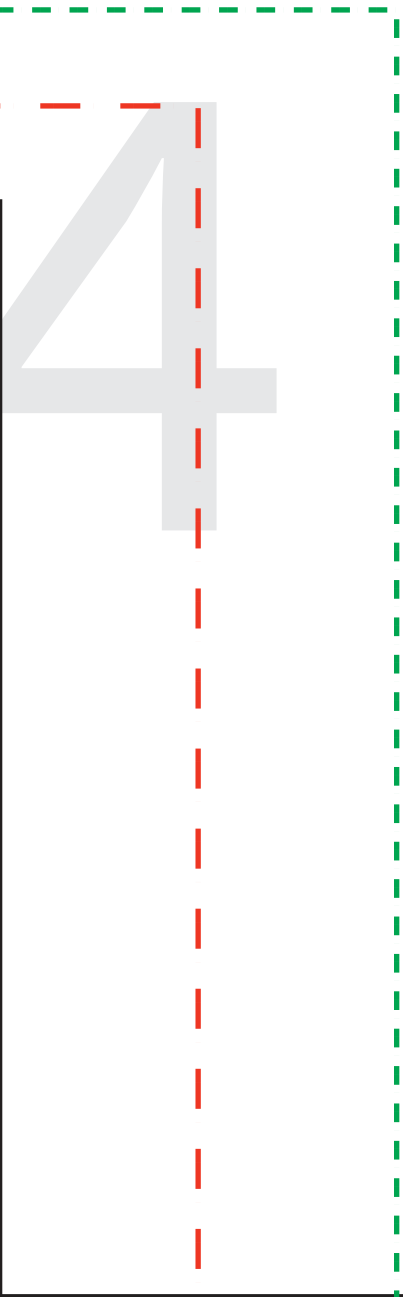
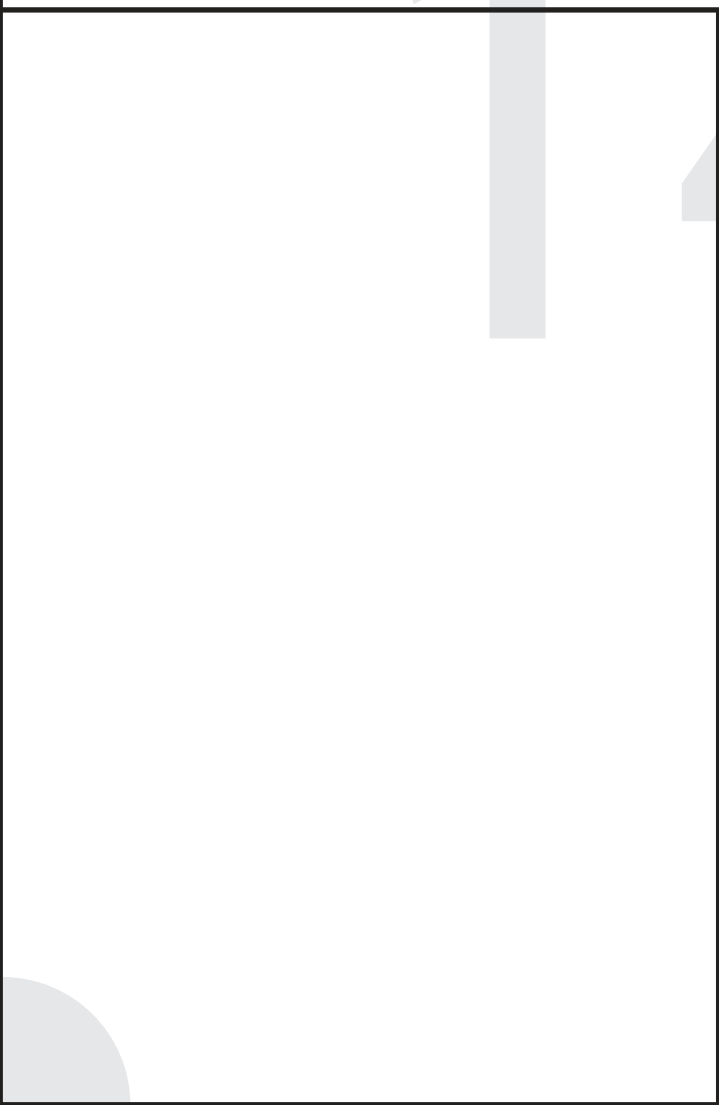

15

16



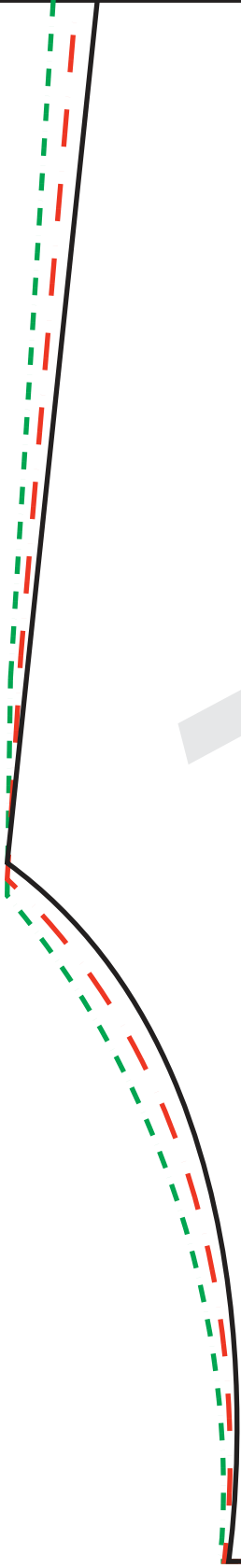

17

18





HAPPIESTCAMPER.COM

Kimono Back Cut 1 on fold

3/8" seam allowance already included

Direction of Stretch

Grainline



20



21

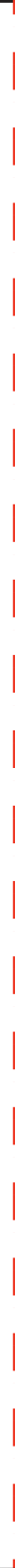

22

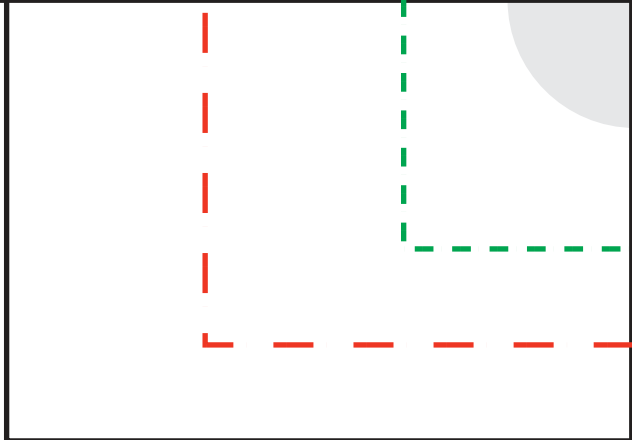

The page features a white background with a black border. At the top, there are two horizontal dashed lines: a green one above a red one. In the corners, there are light gray circular shapes. The numbers '23' are centered in a large, light gray font.

23

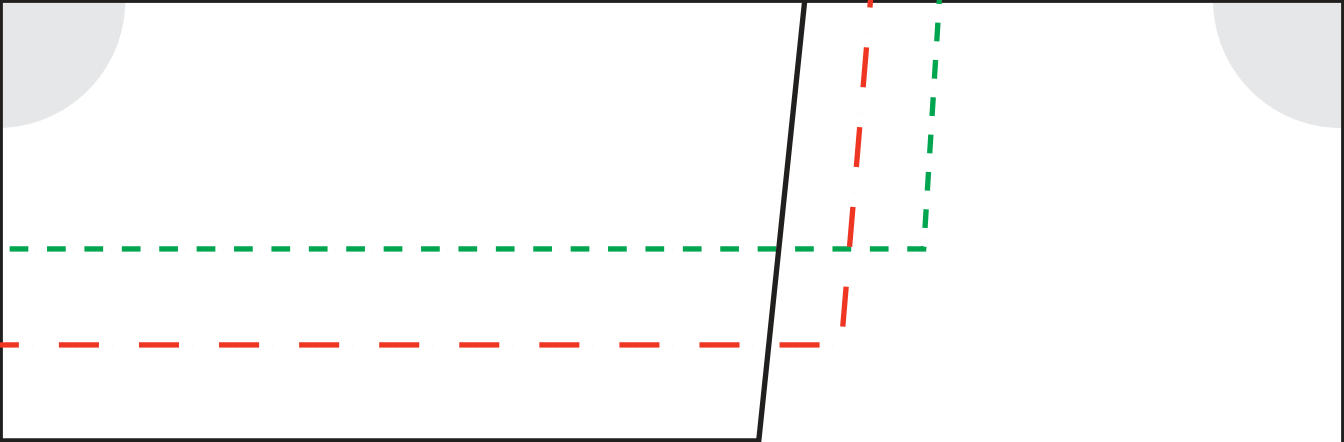

24