



HAPPIESTCAMPER.COM

Size Key Chart

Small -----

Medium - - - - -

Large _____

2 x 2 inch
Test
Square

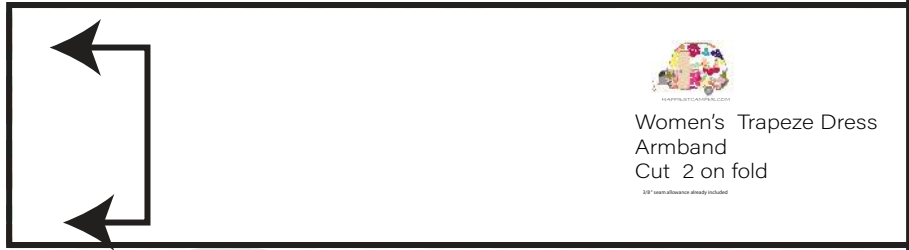

2



HAPPYSTITCH.COM

Women's Trapeze Dress
Neckband
Cut 1 on fold

3/8" seam allowance already included



3

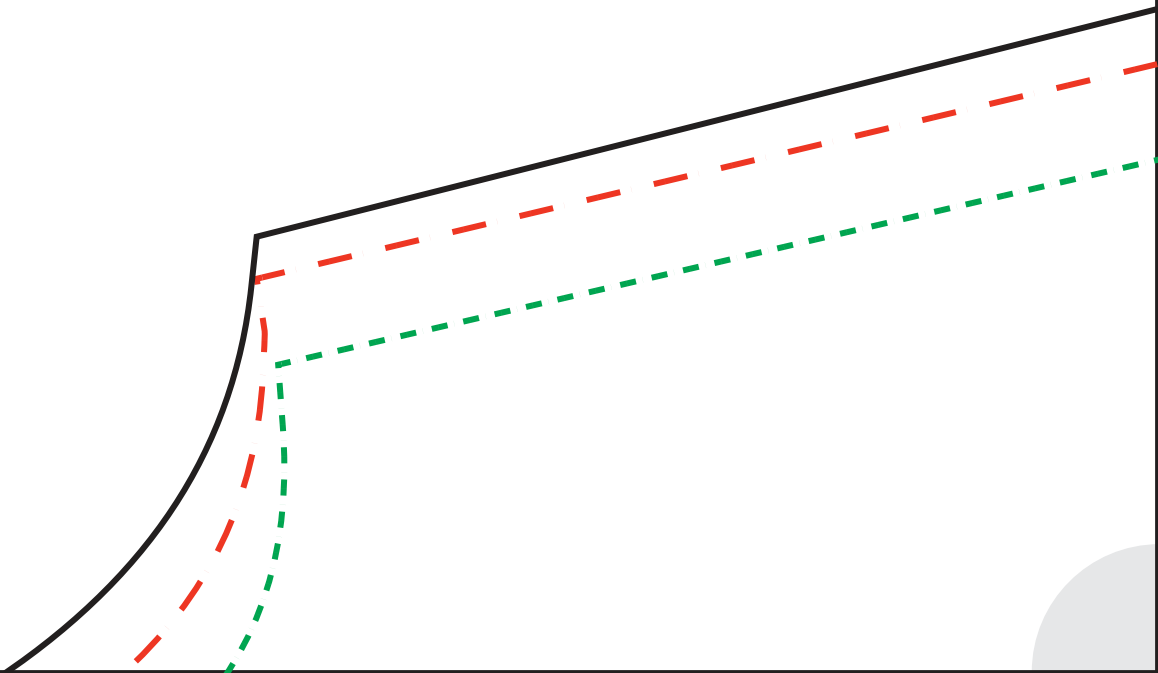



4

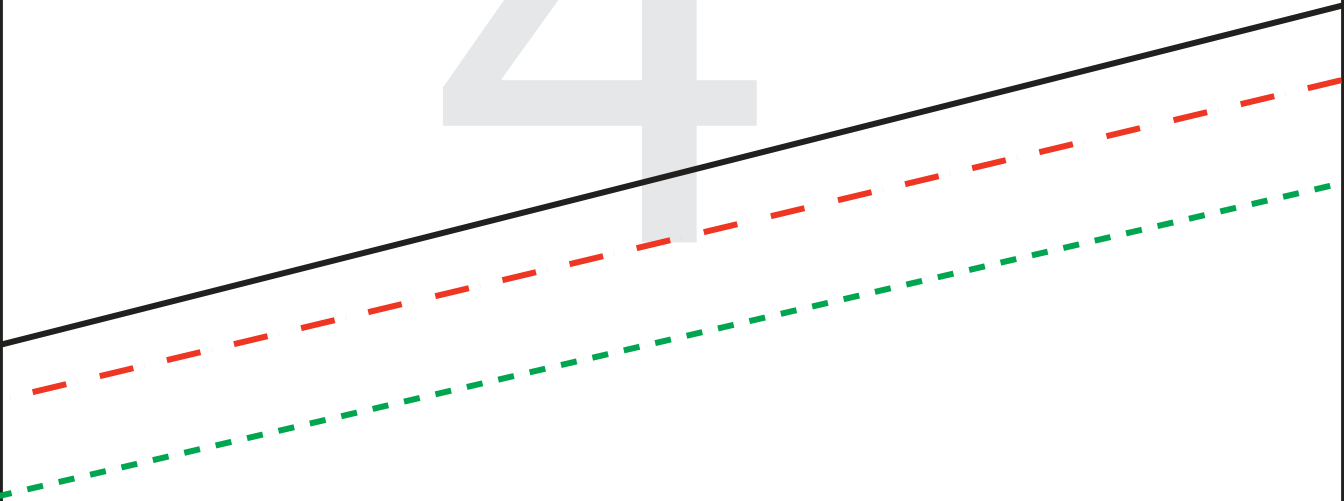

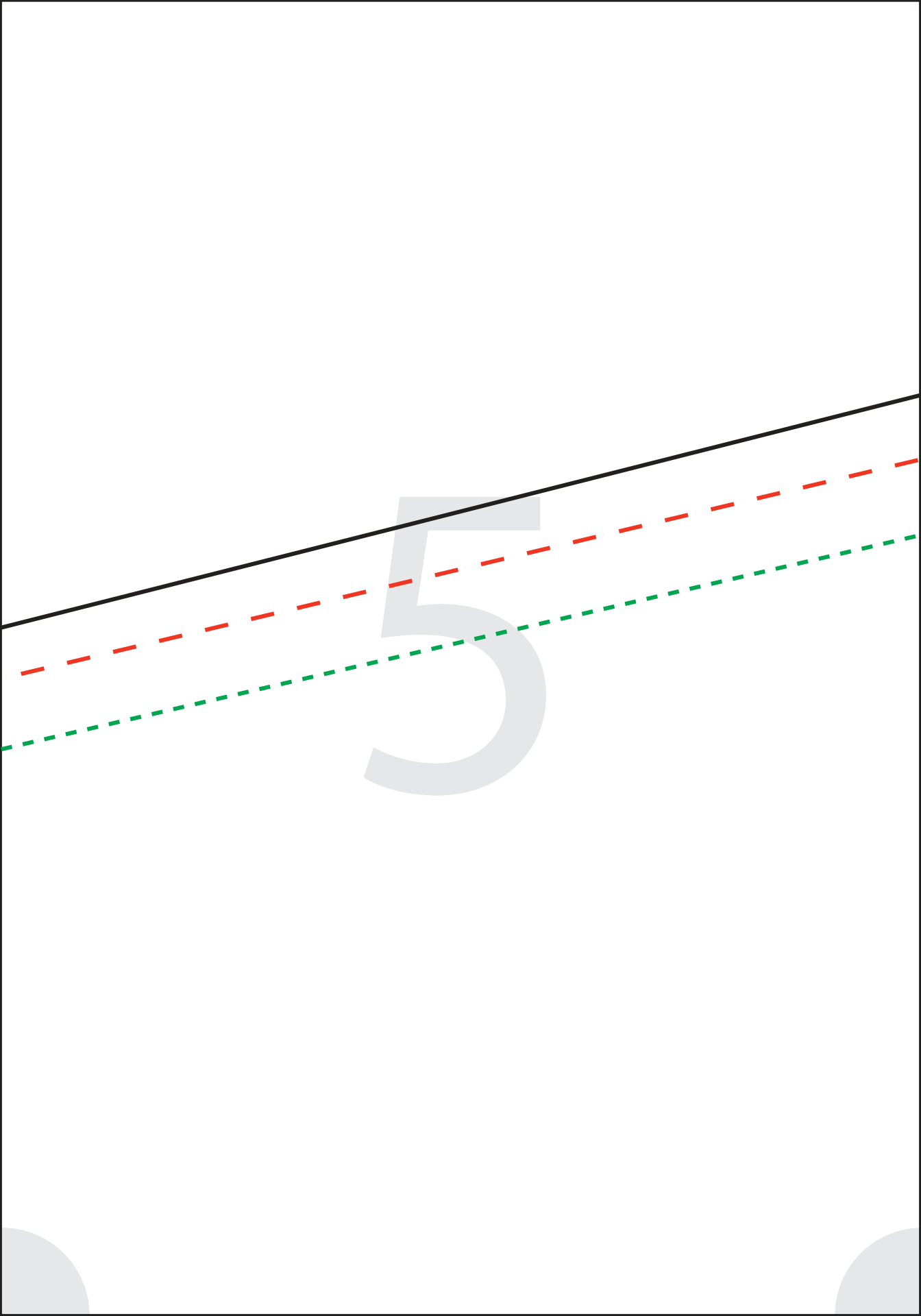

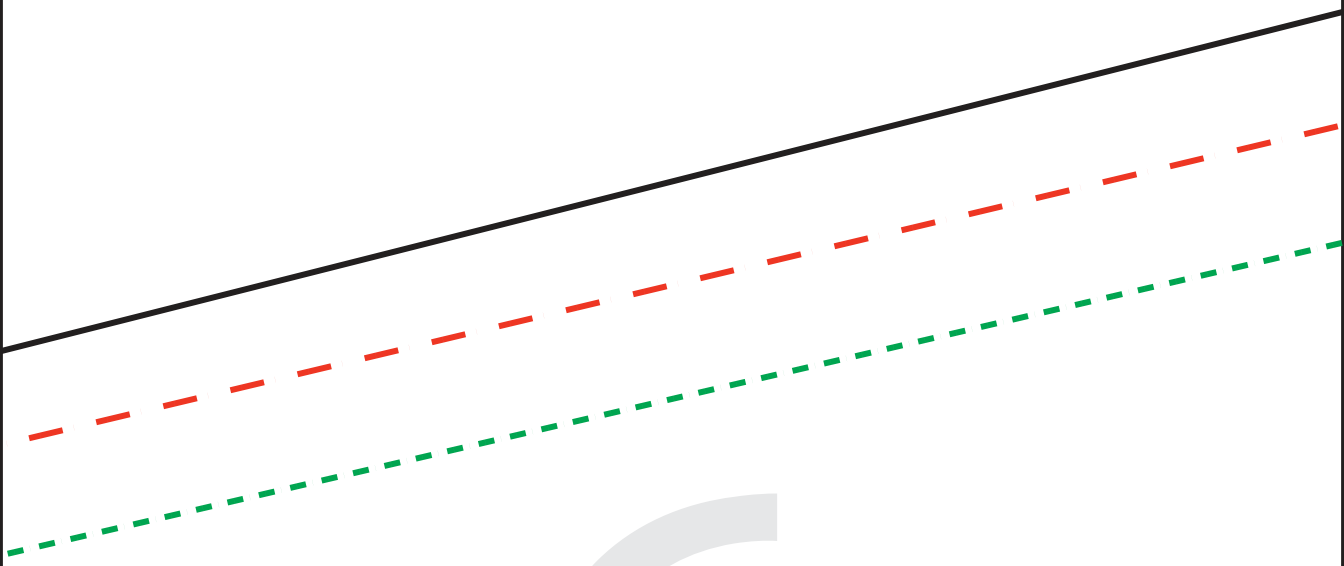

6



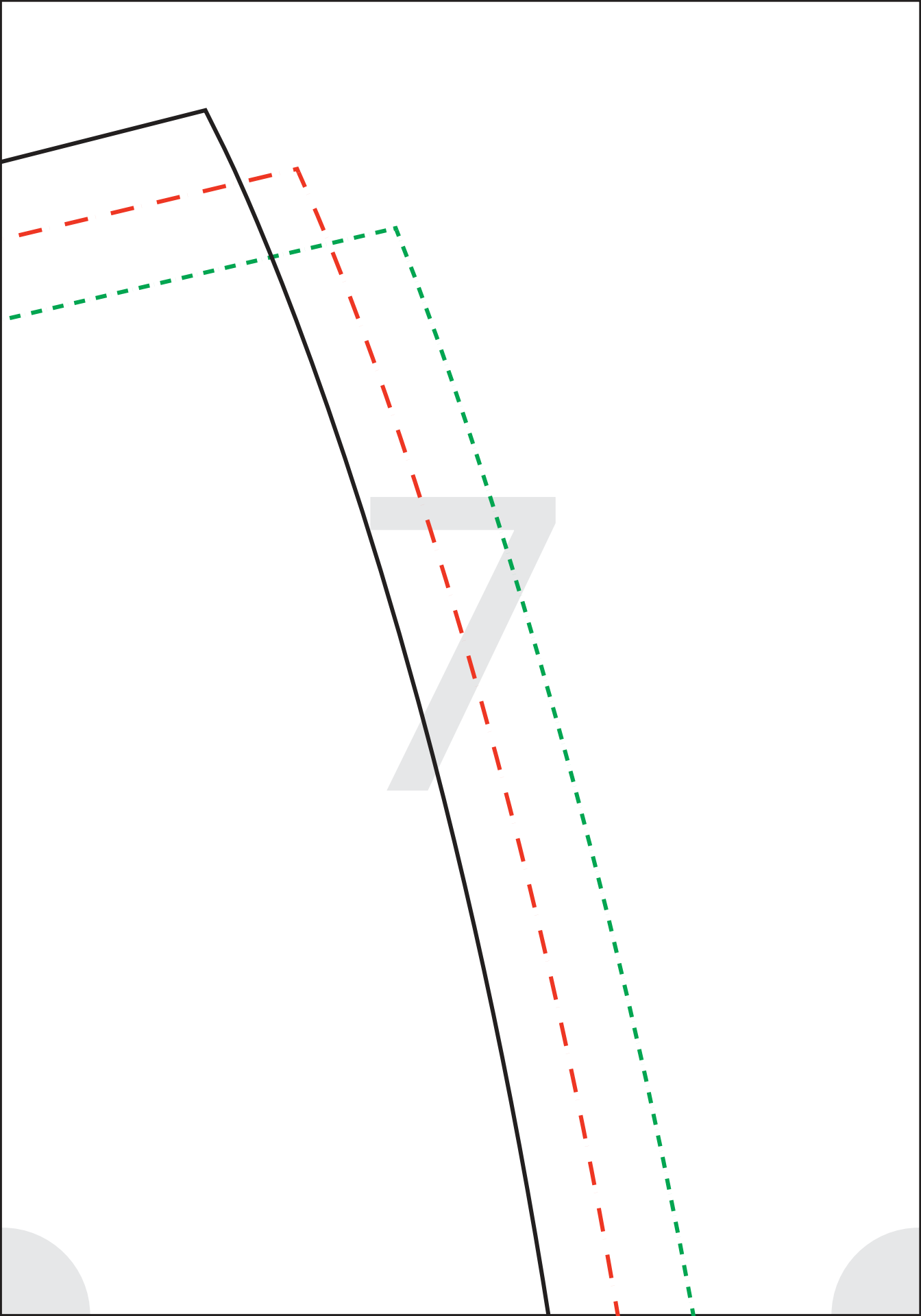

8

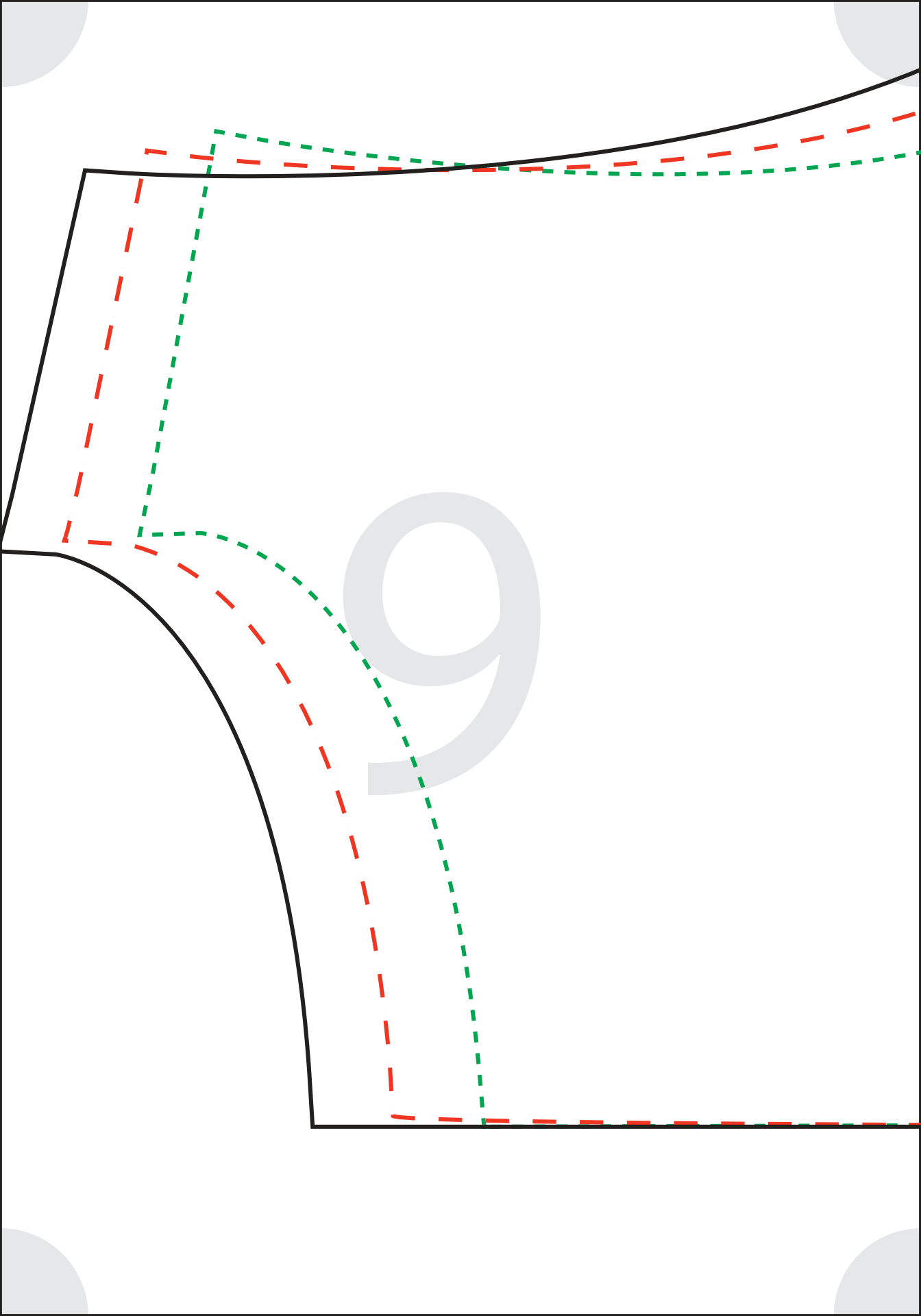

10



HAPPIESTCAMPER.COM

Women's Trapeze Dress

BACK

BACK

Cut 1 on fold

3/8" seam allowance already included

Direction of Stretch



12

Fold

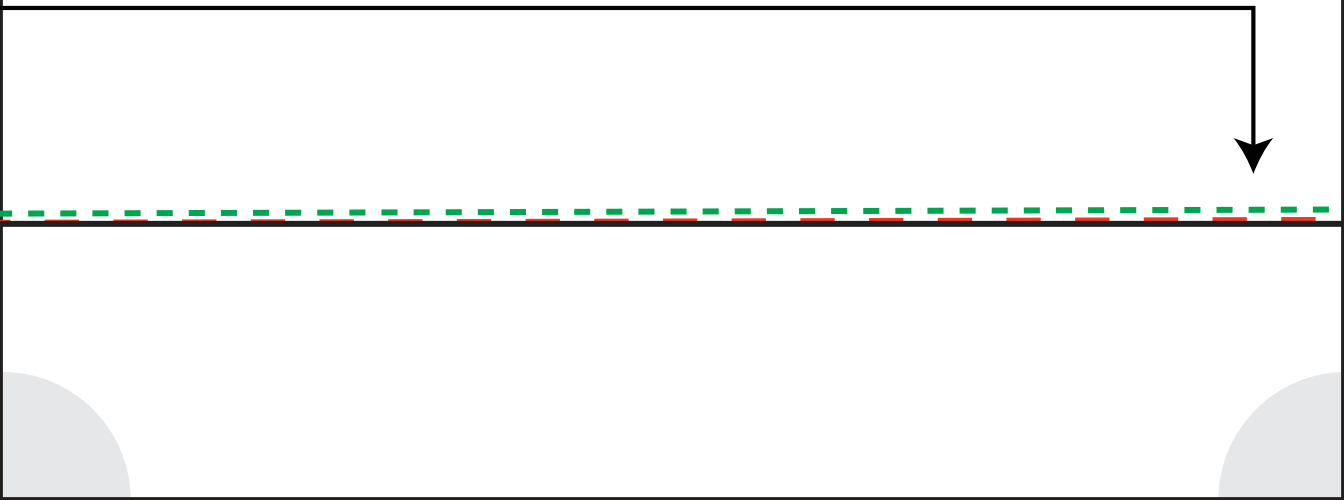

13

14

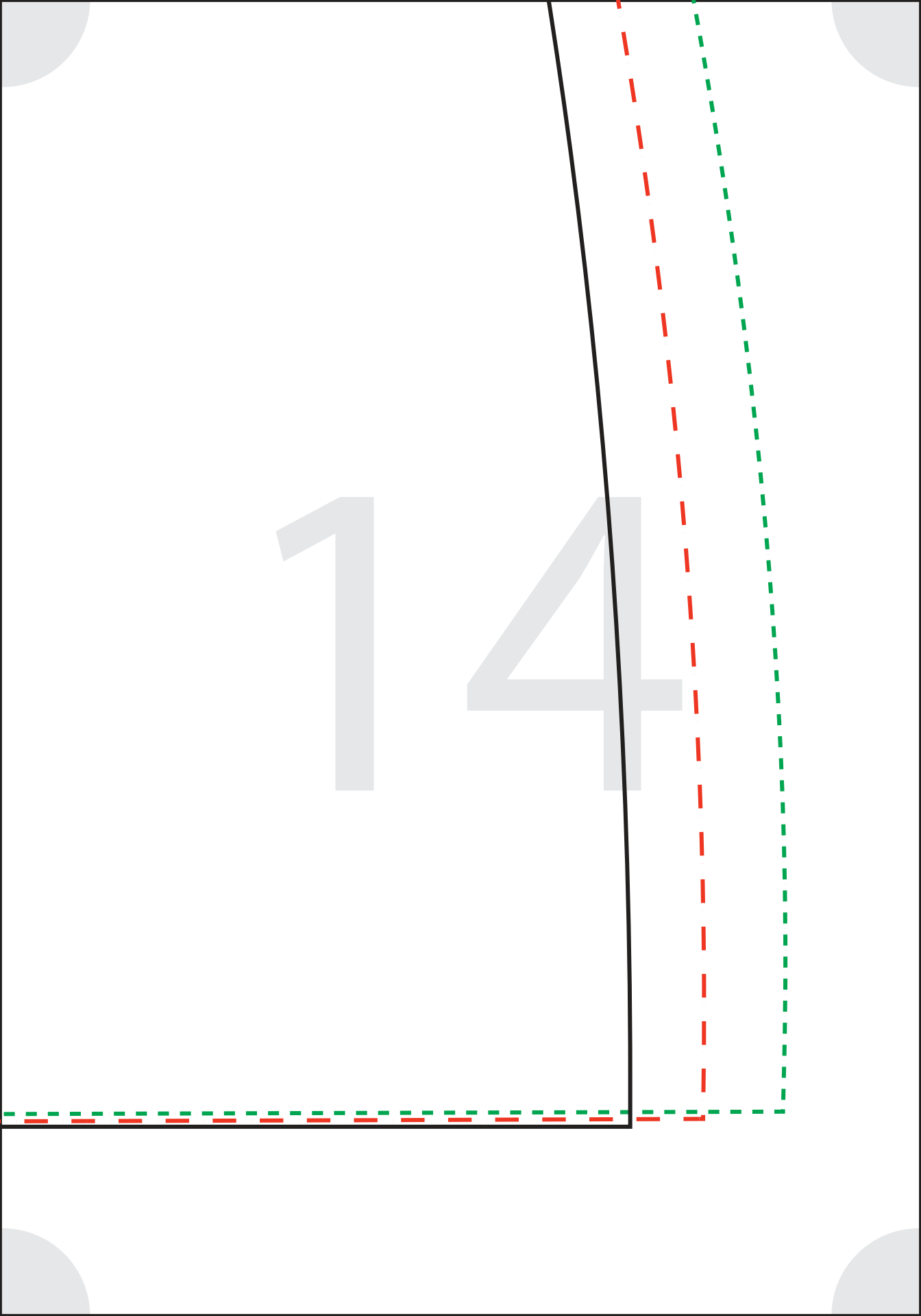

15

16

17

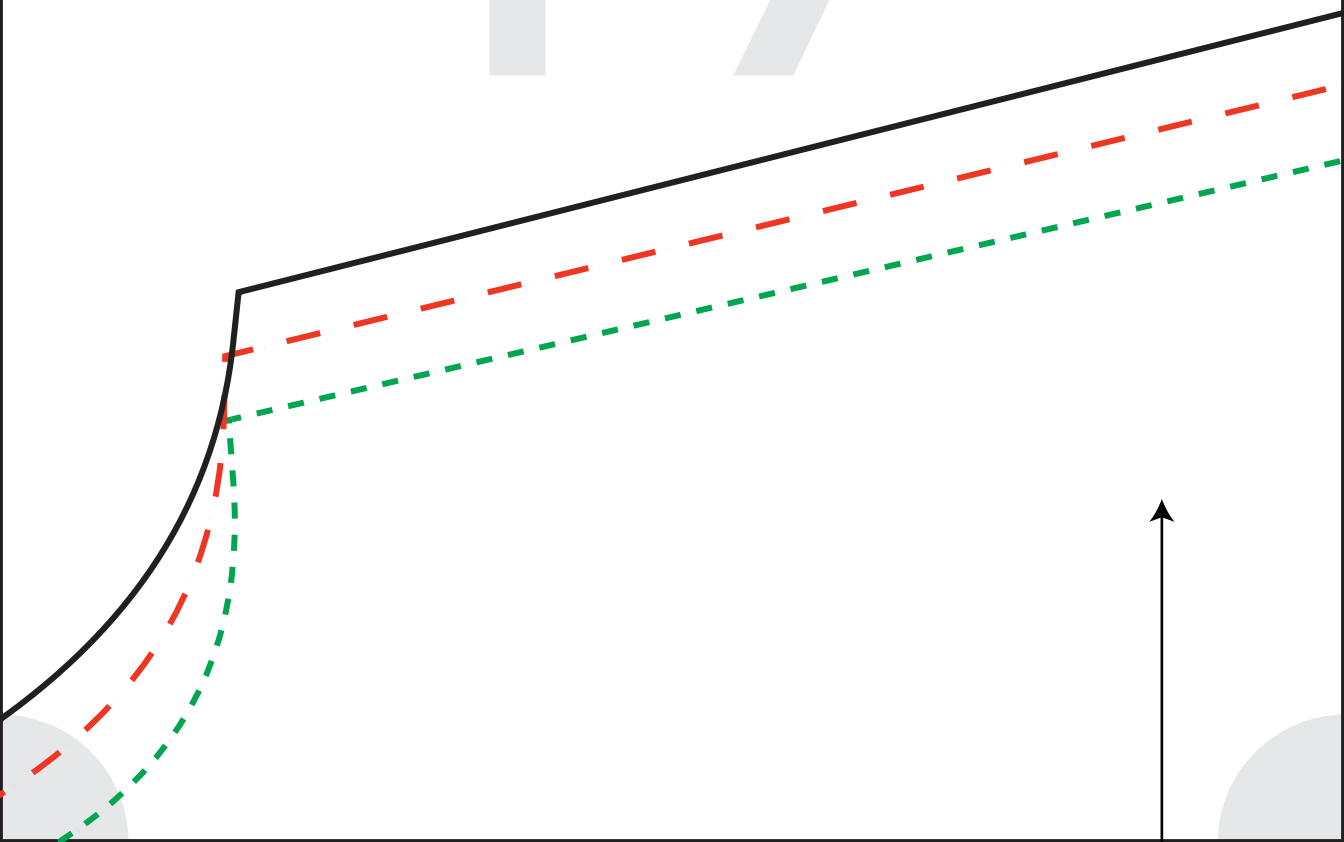

18

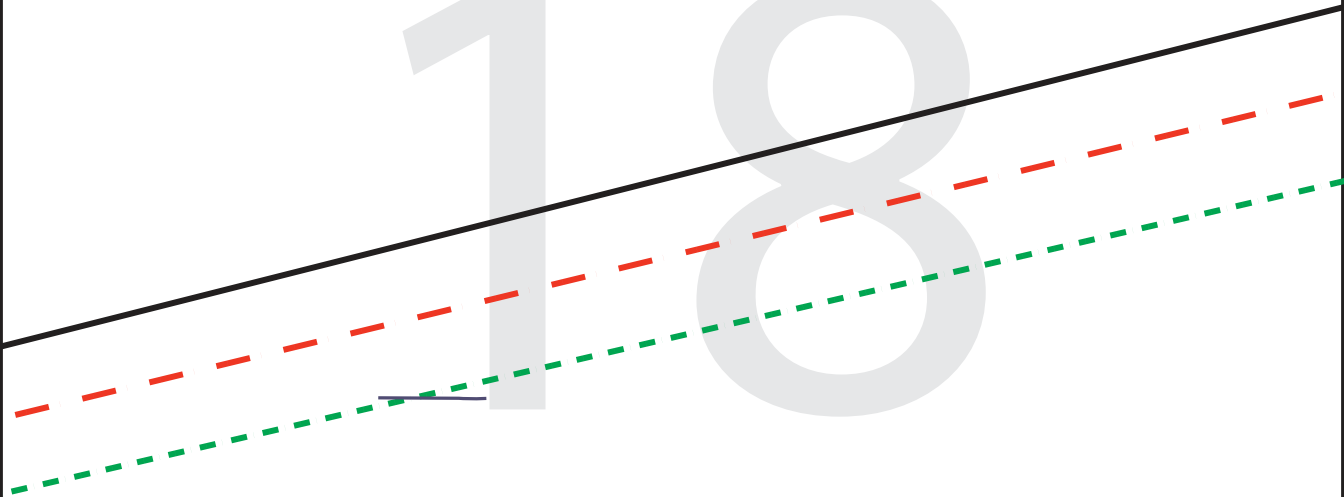

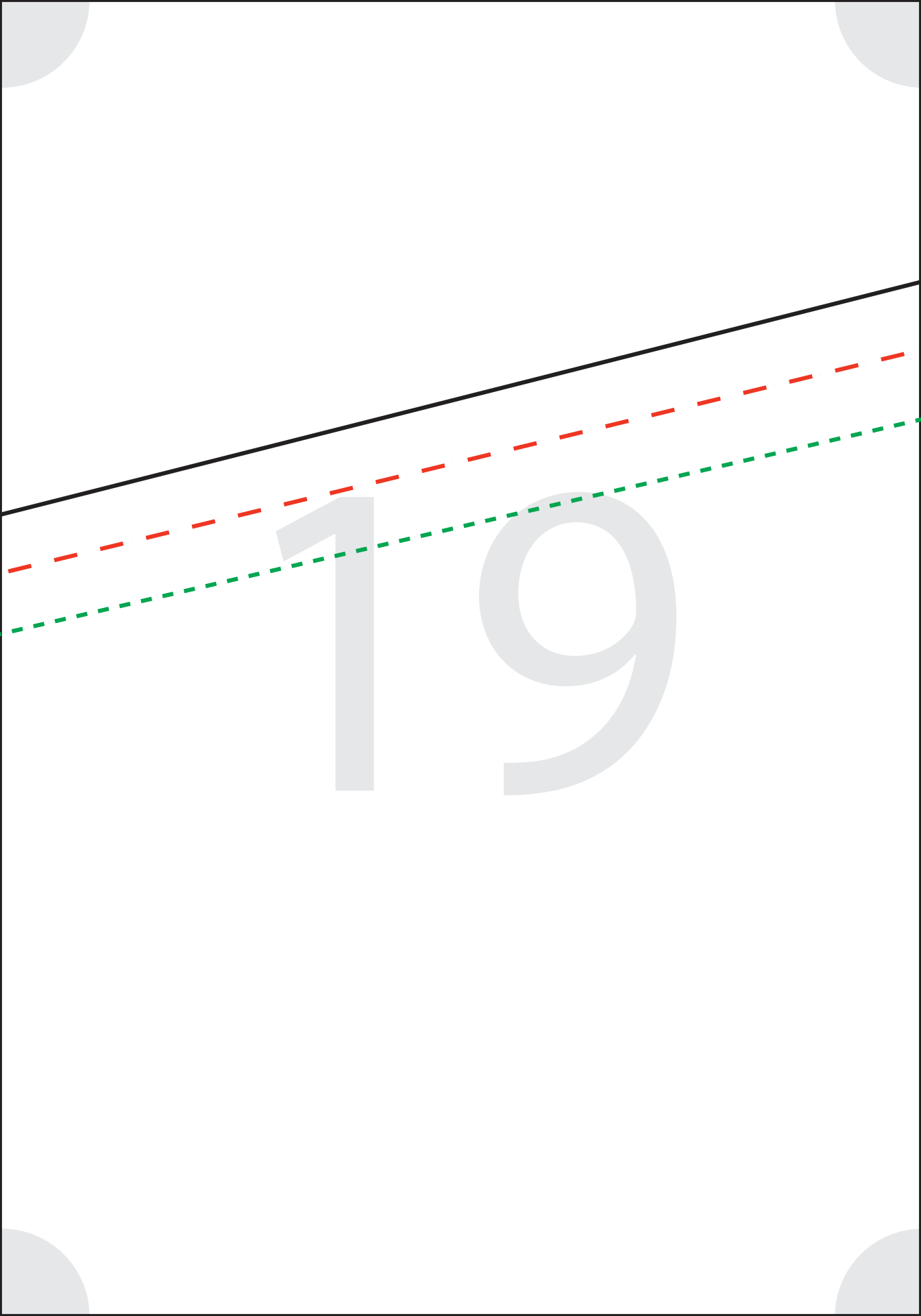

19

The page features a white background with a black border. In the top-left and bottom-right corners, there are light gray circular shapes. Three parallel lines slope upwards from left to right: a solid black line at the top, a dashed red line in the middle, and a dashed green line at the bottom. The number '20' is centered in the lower half of the page in a large, light gray font.

20

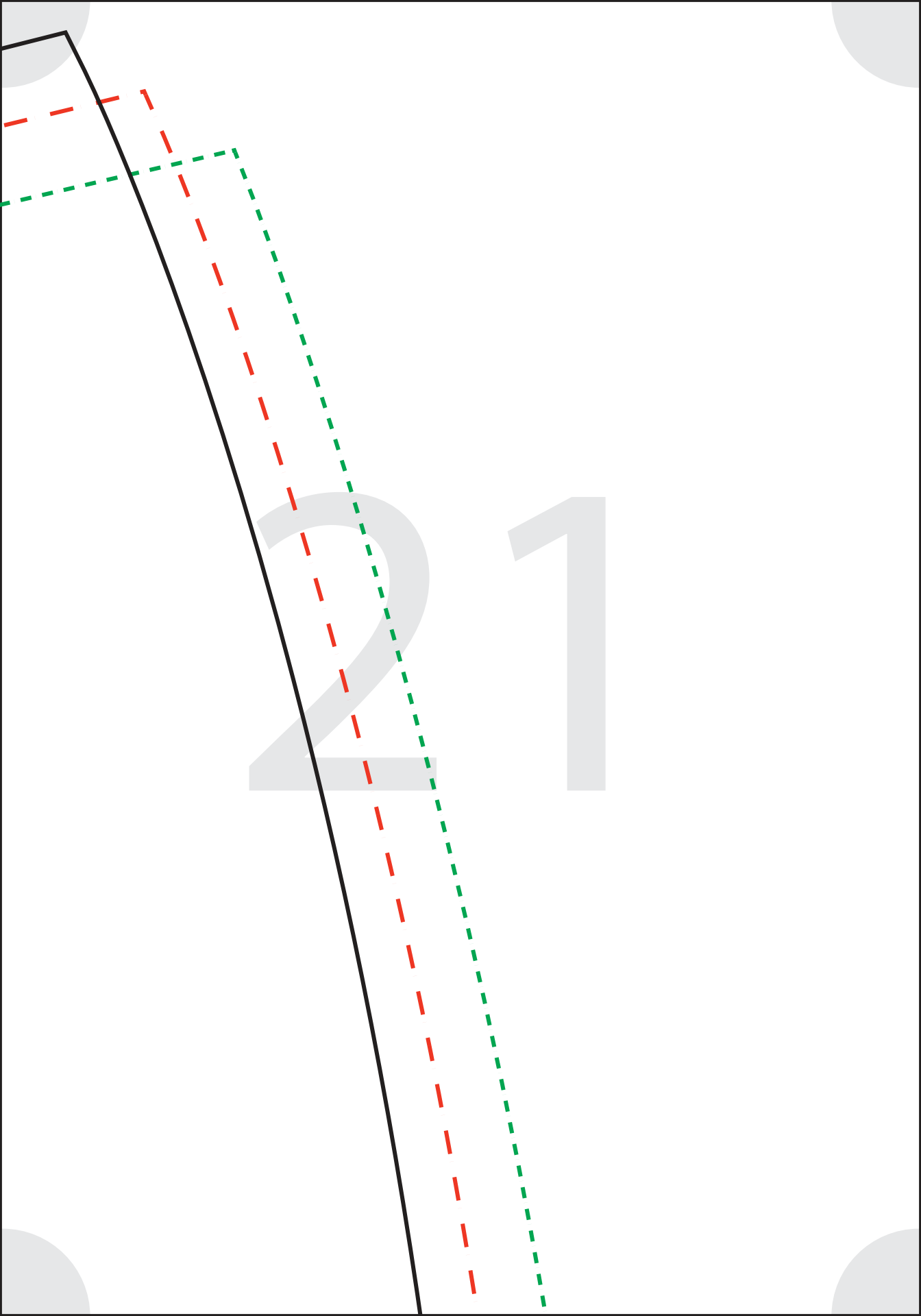

22

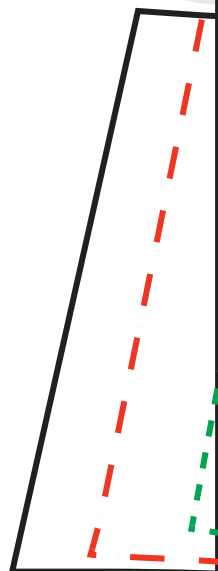

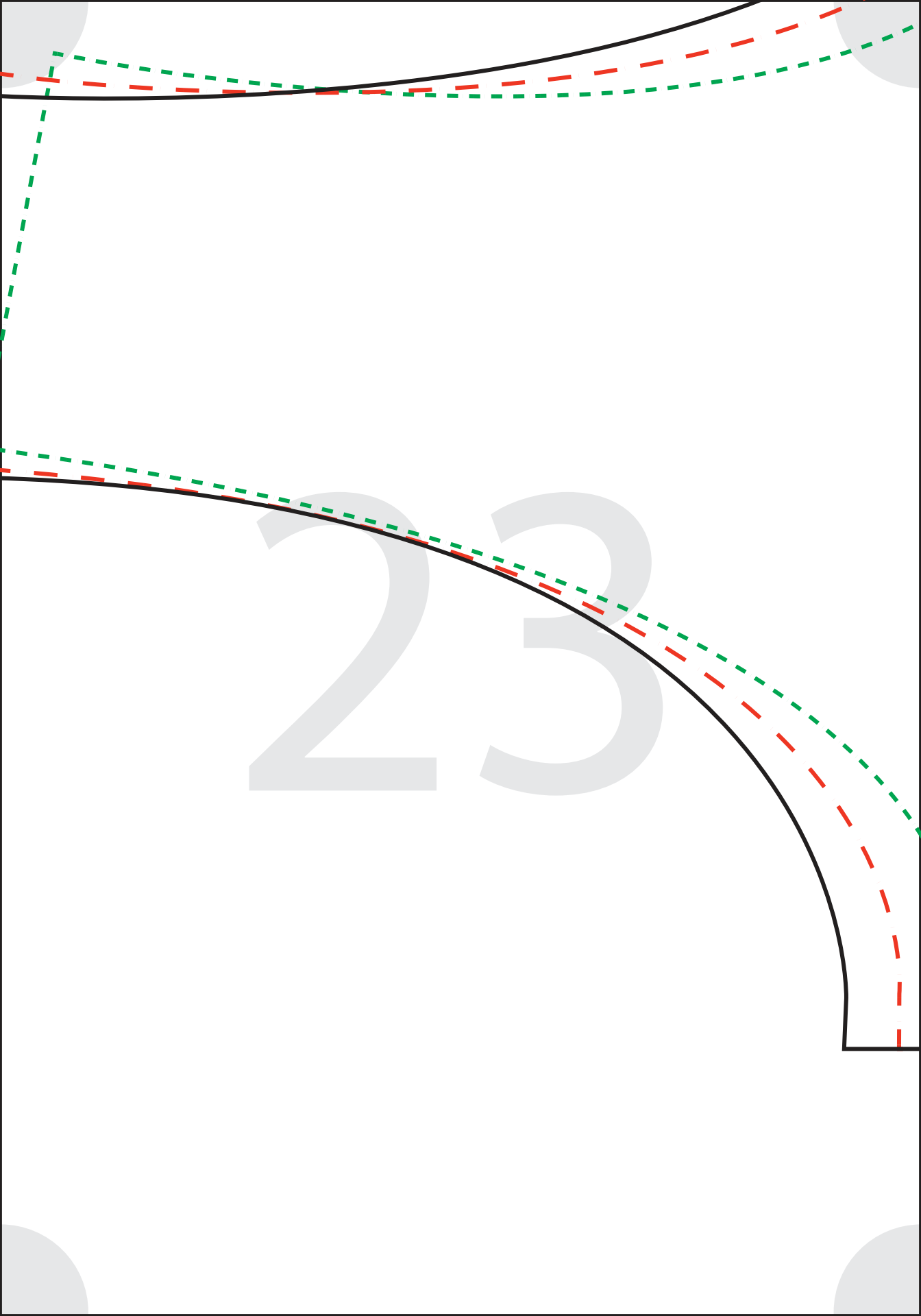

23



HAPPIESTCAMPER.COM

Women's Trapeze Dress

FRONT

Cut 1 on fold

3/8" seam allowance already included

Direction of Stretch



25

Fold



26



27

28

