



HAPPIESTCAMPER.COM

Size Key Chart

Small -----

Medium -----

Large _____

2 x 2 inch
Test
Square

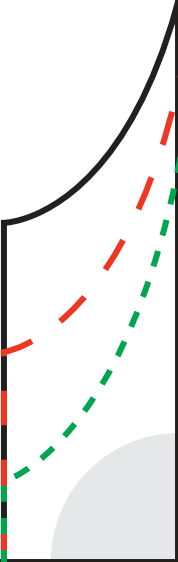



Sundress
Flapper Dress
Cut 4

U.S. women's sizes only. See pattern for details.

der Layer
Fold - Tier 1

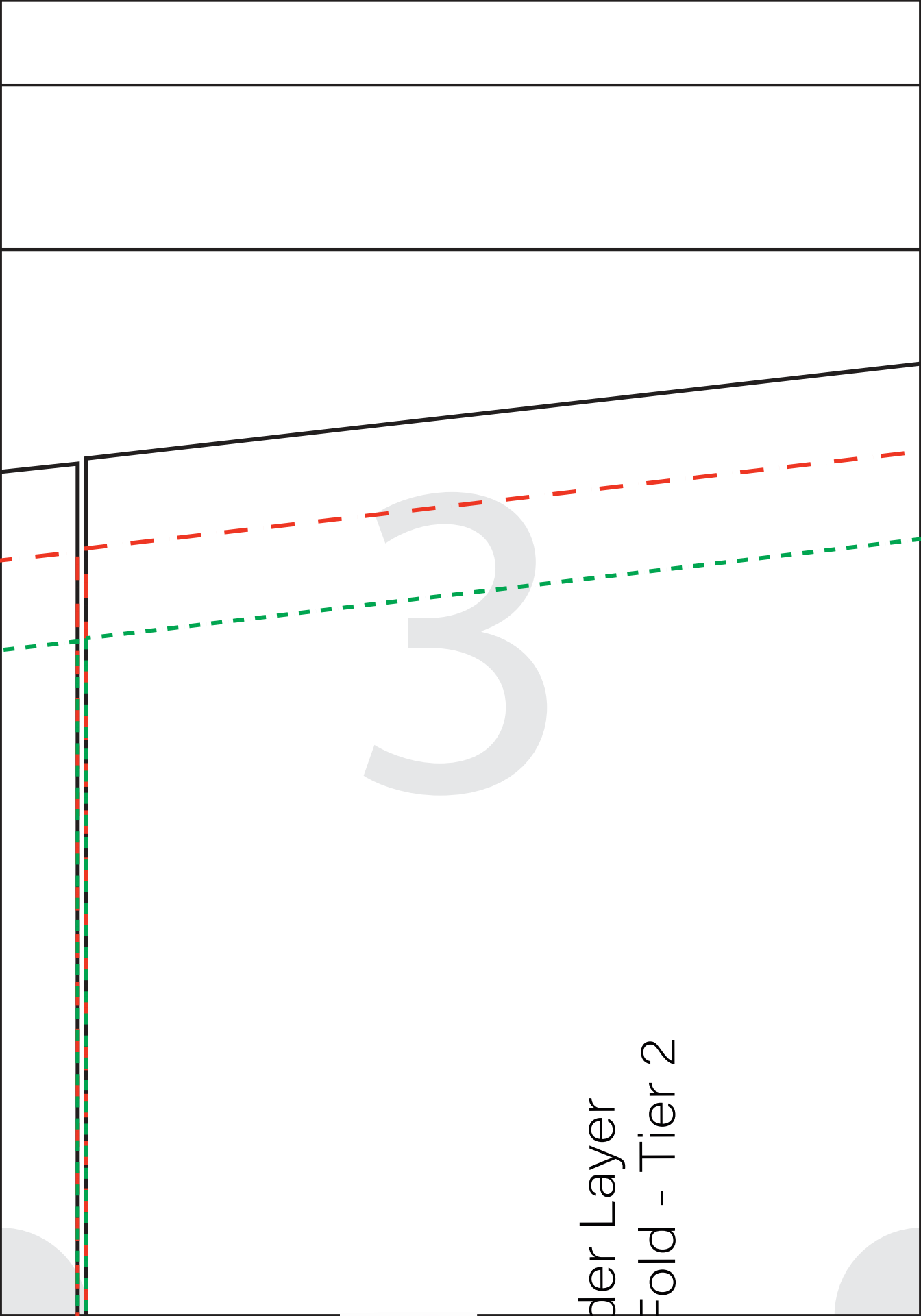

der Layer
Fold - Tier 2

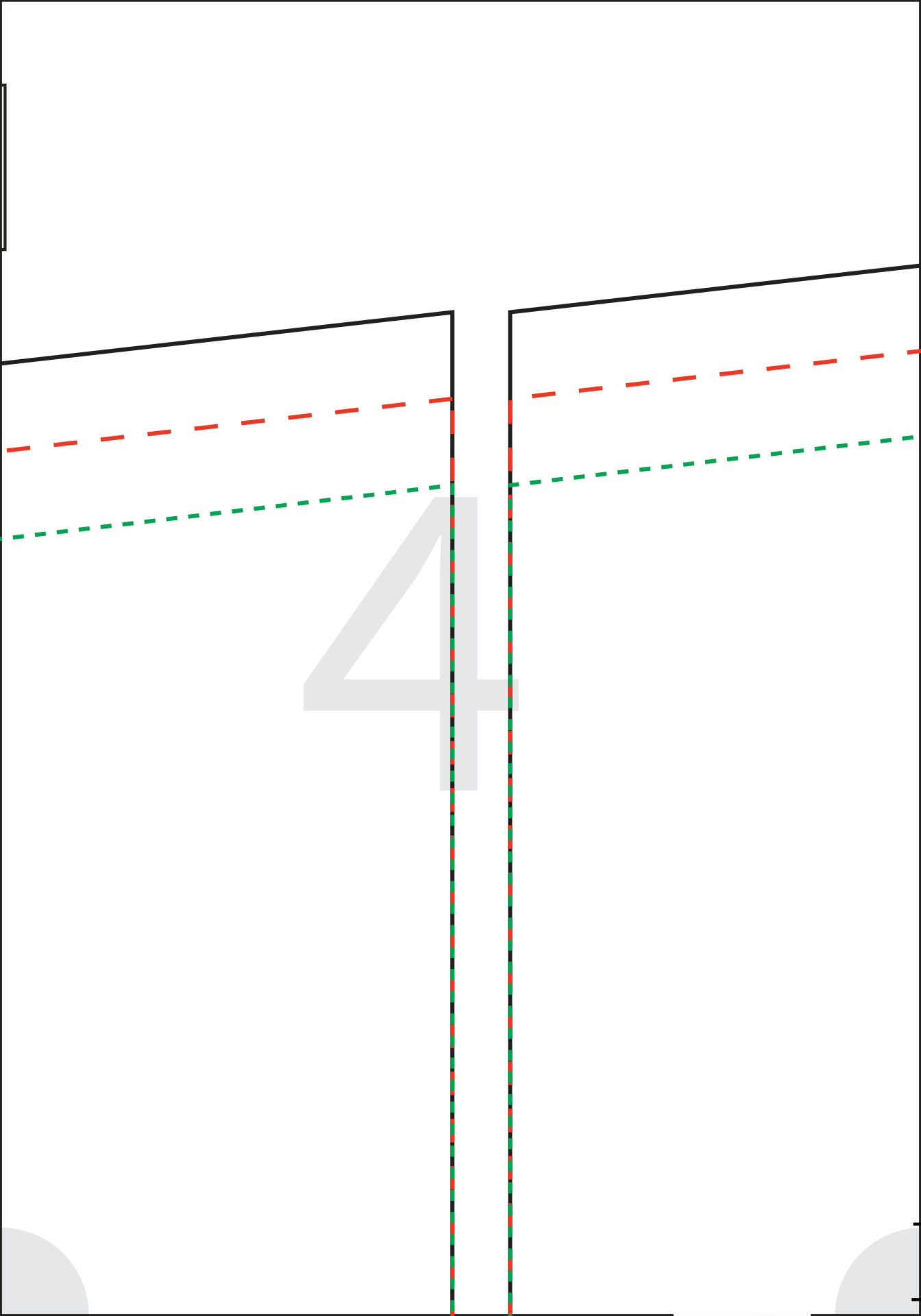

der Layer
Fold - Tier 3

5

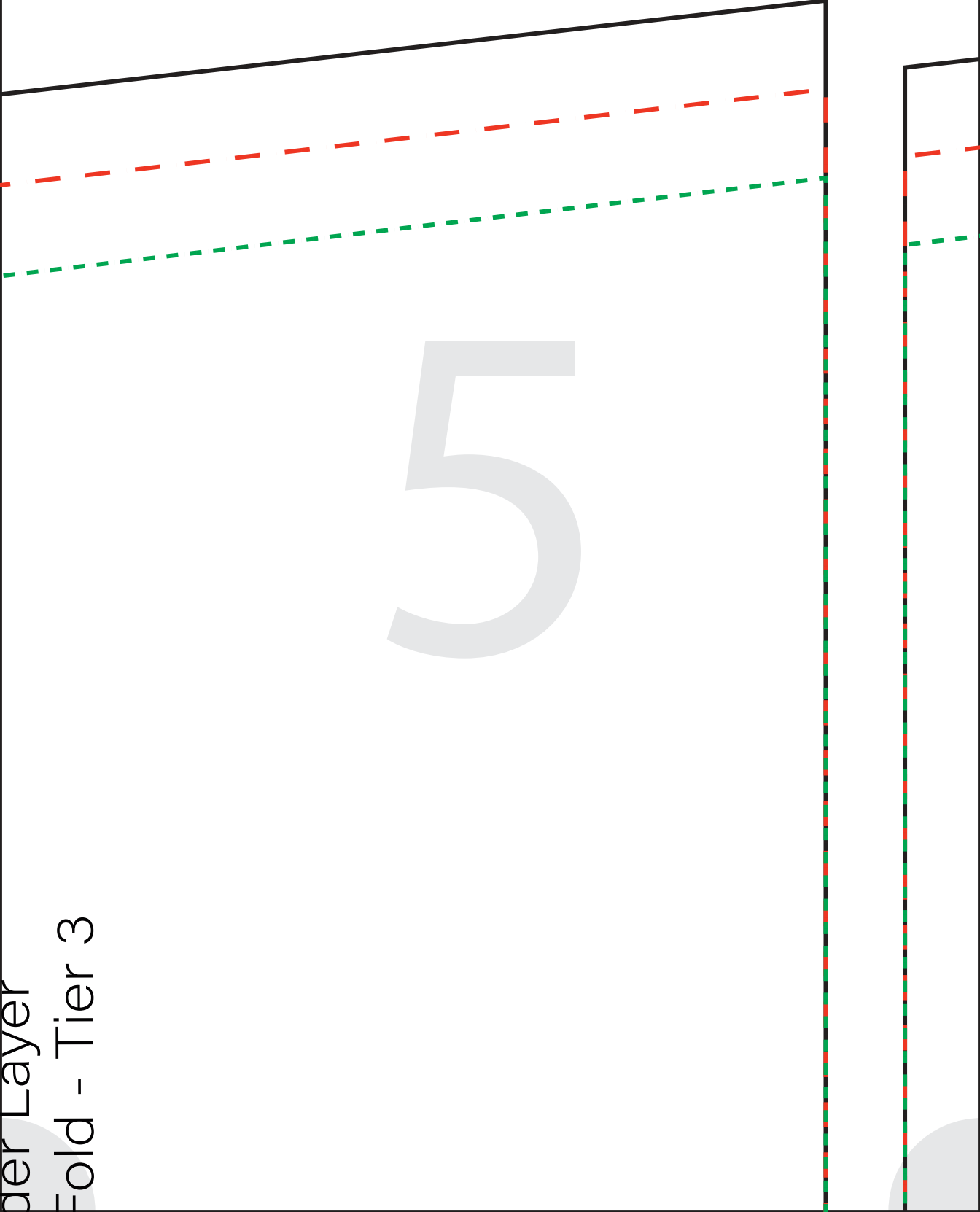

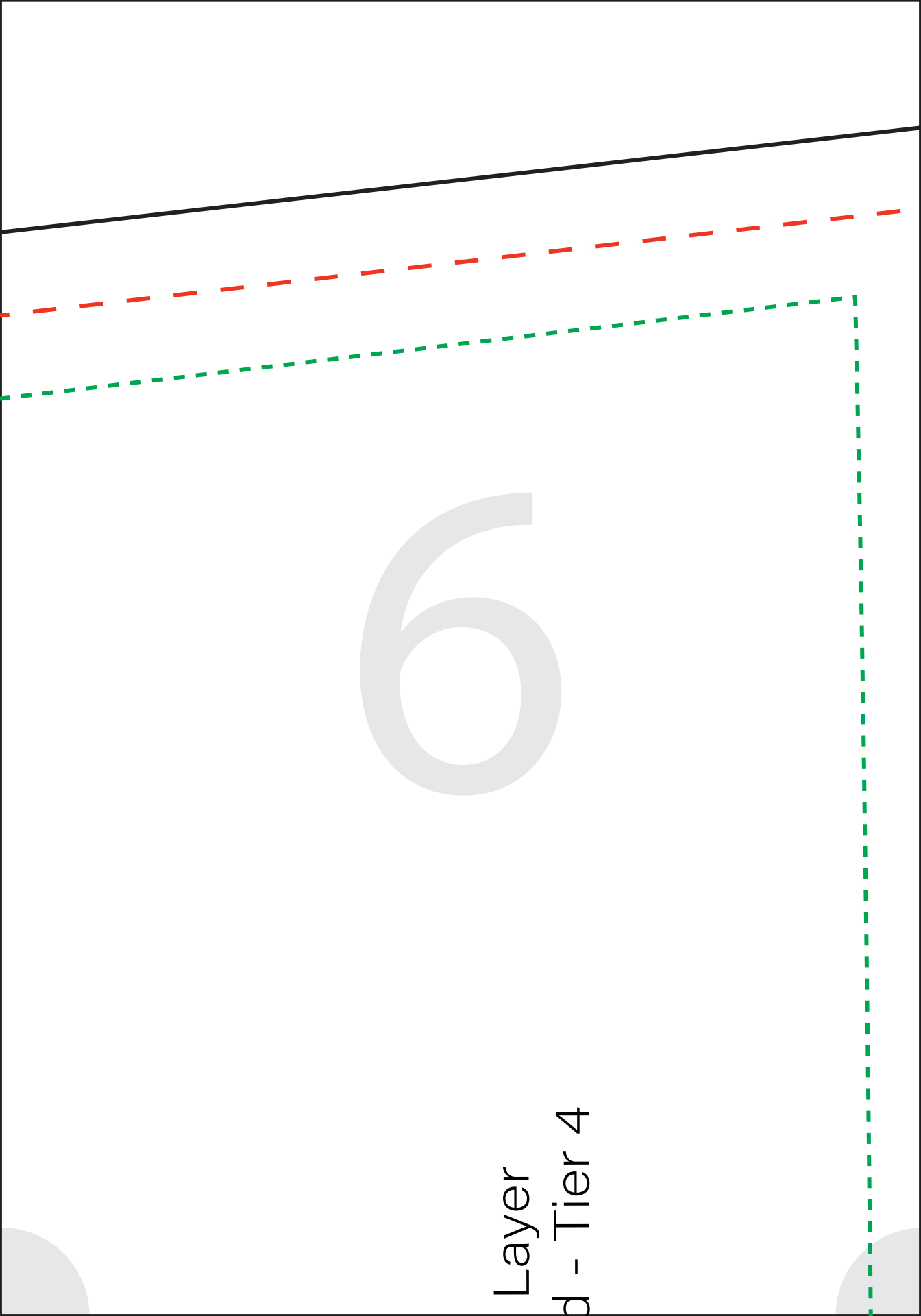

6

Layer
4 - Tier 4

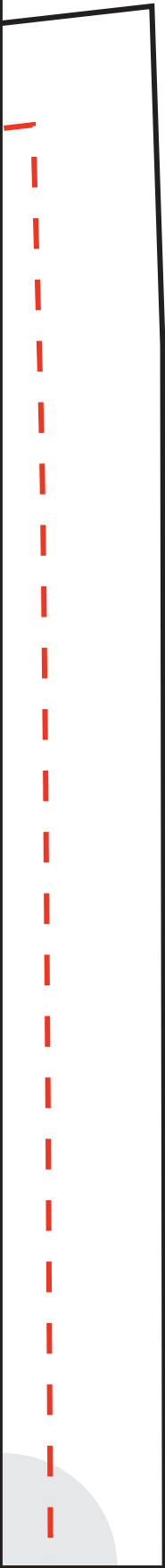

7

8

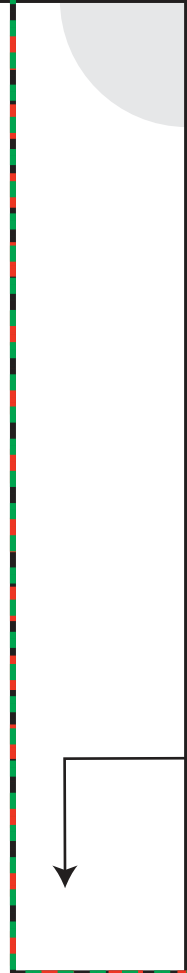



HAPPIESTCAMPER.COM

Sundress Dress Undie Cut 2 on F

3/8" seam allowance already included

FOLD

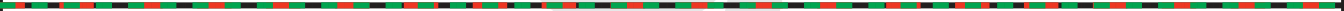
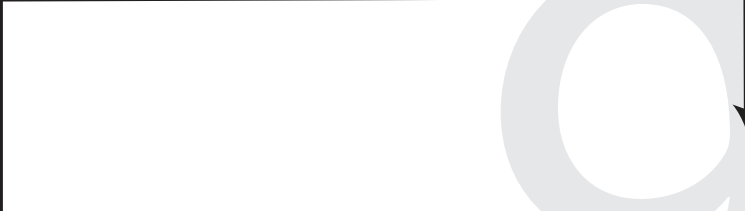



HAPPIESTCAMPER.COM

Sundress Dress Undie Cut 2 on fl

3/8" seam allowance already included

FOLD

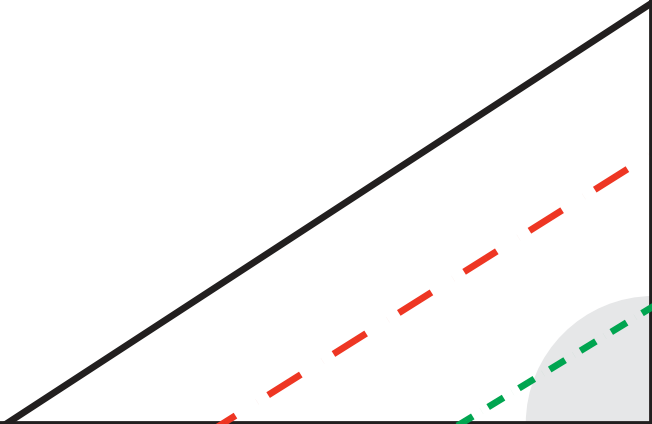



HAPPIESTCAMPER.COM

Sundress

Tracing practice area for the word "Sundress". The word is written in large, light grey letters. The letters 'S' and 'D' are partially enclosed by a dashed red line, and the letters 'N' and 'D' are partially enclosed by a dashed green line. A solid black line follows the outline of the word. A small black arrow points to the right, indicating the direction of the tracing path.

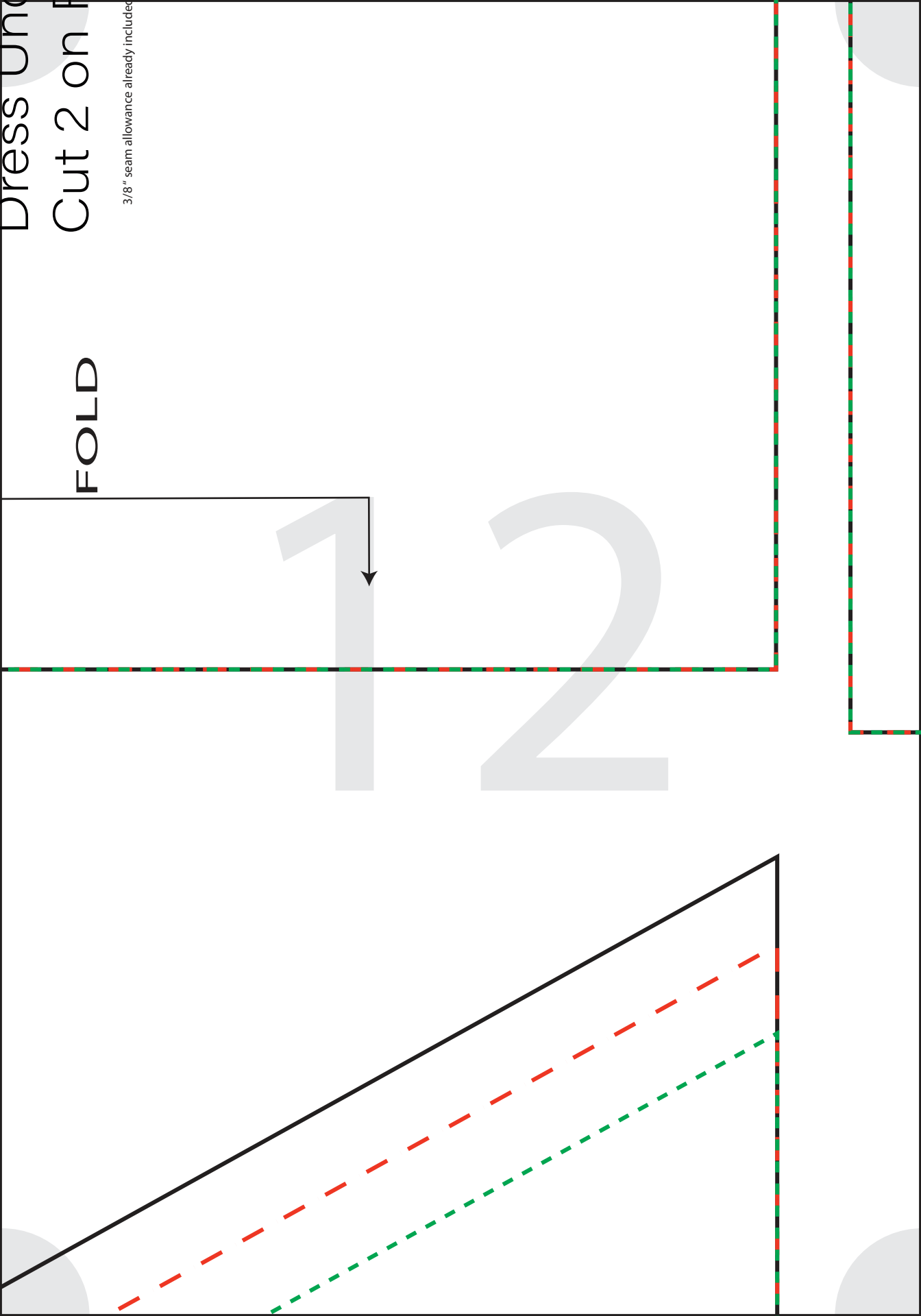
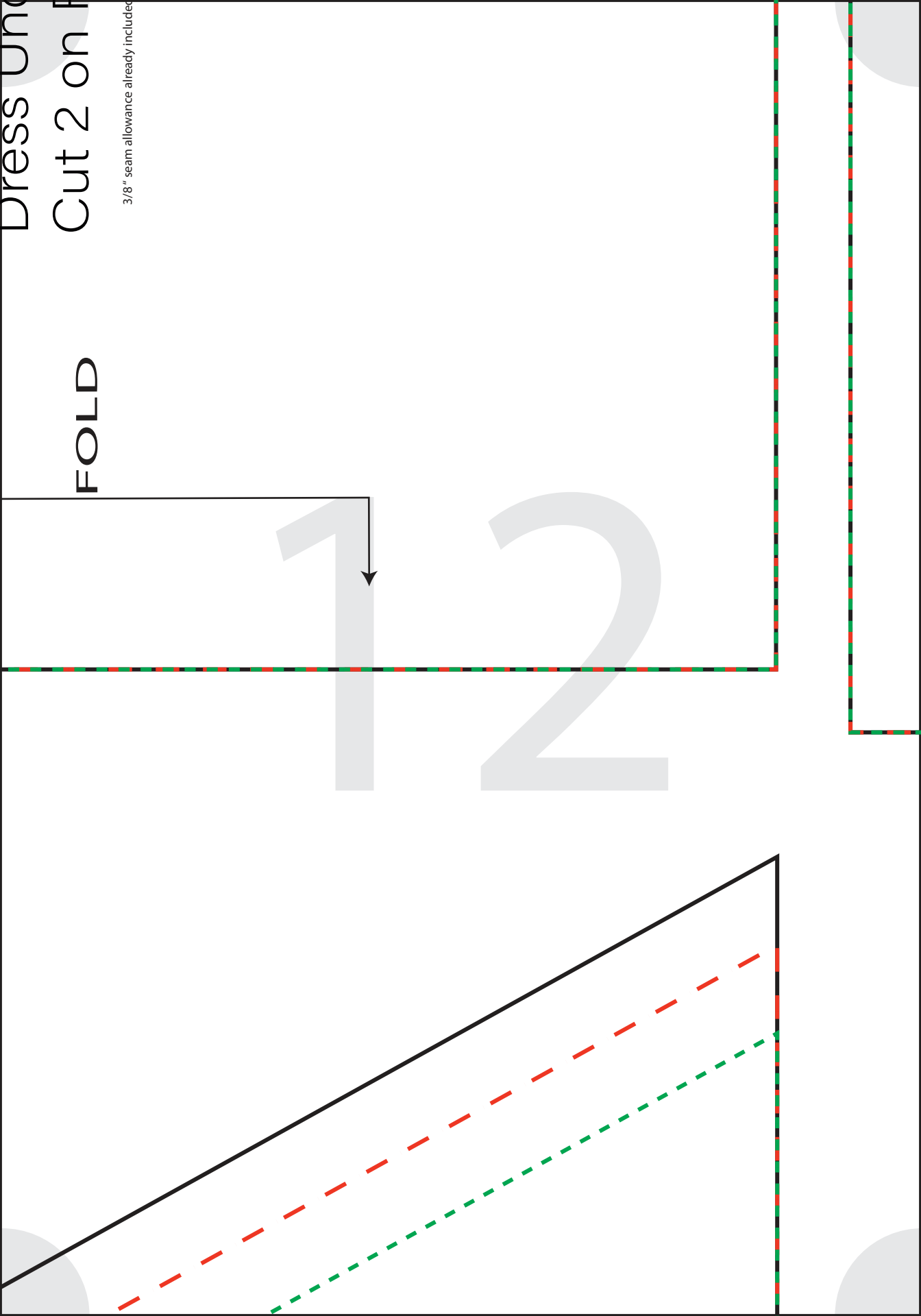

FOLD

Dress Undergarment
Cut 2 on Fold

3/8" seam allowance already included



HAPPIESTCAMPERS.COM

Sundress Dress Under Cut 2 on Fold

3/8" seam allowance already included

FOLD

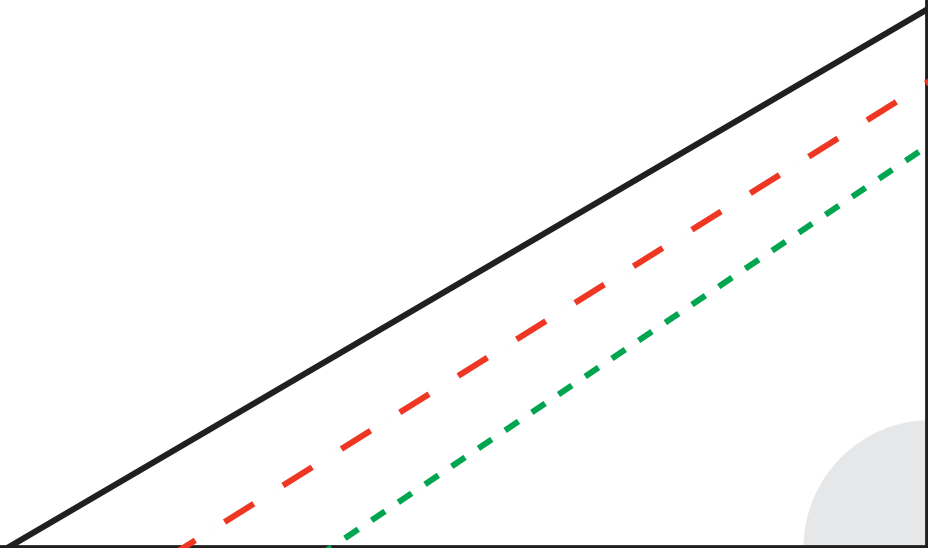

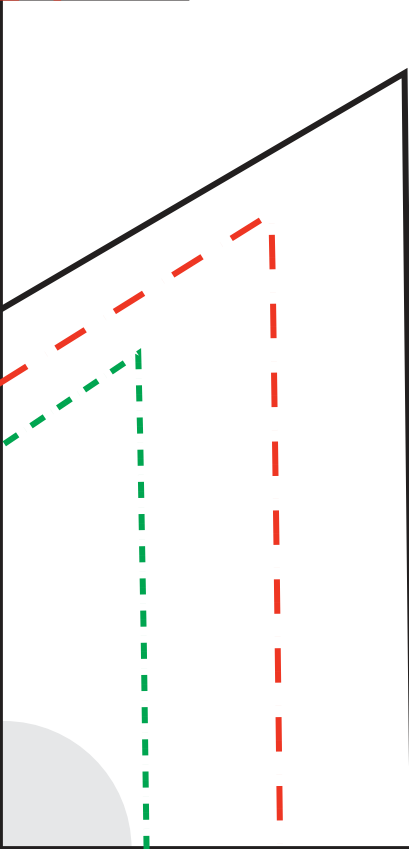
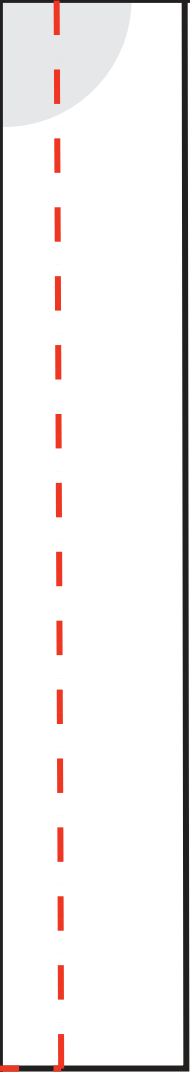

14

15

16

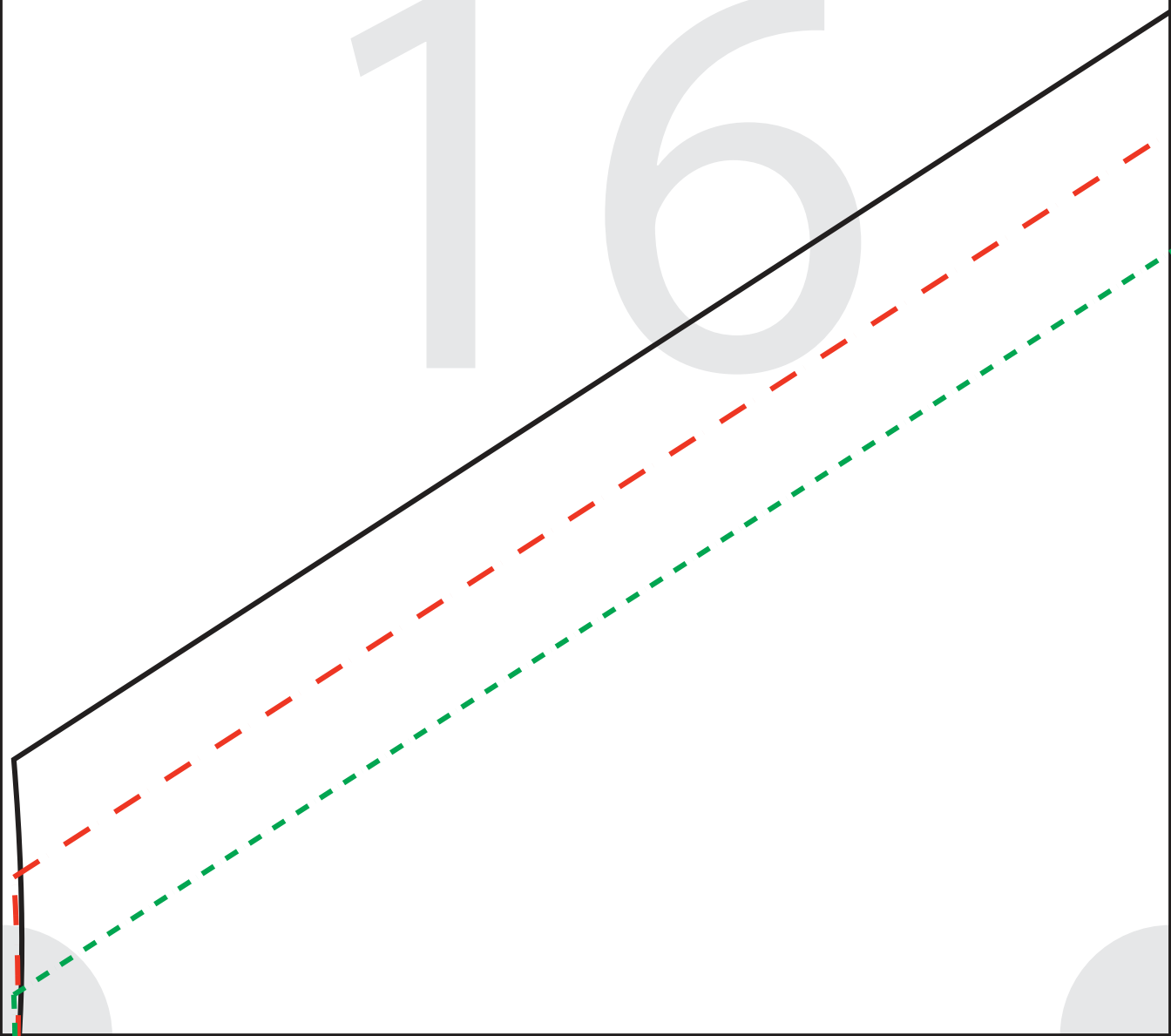

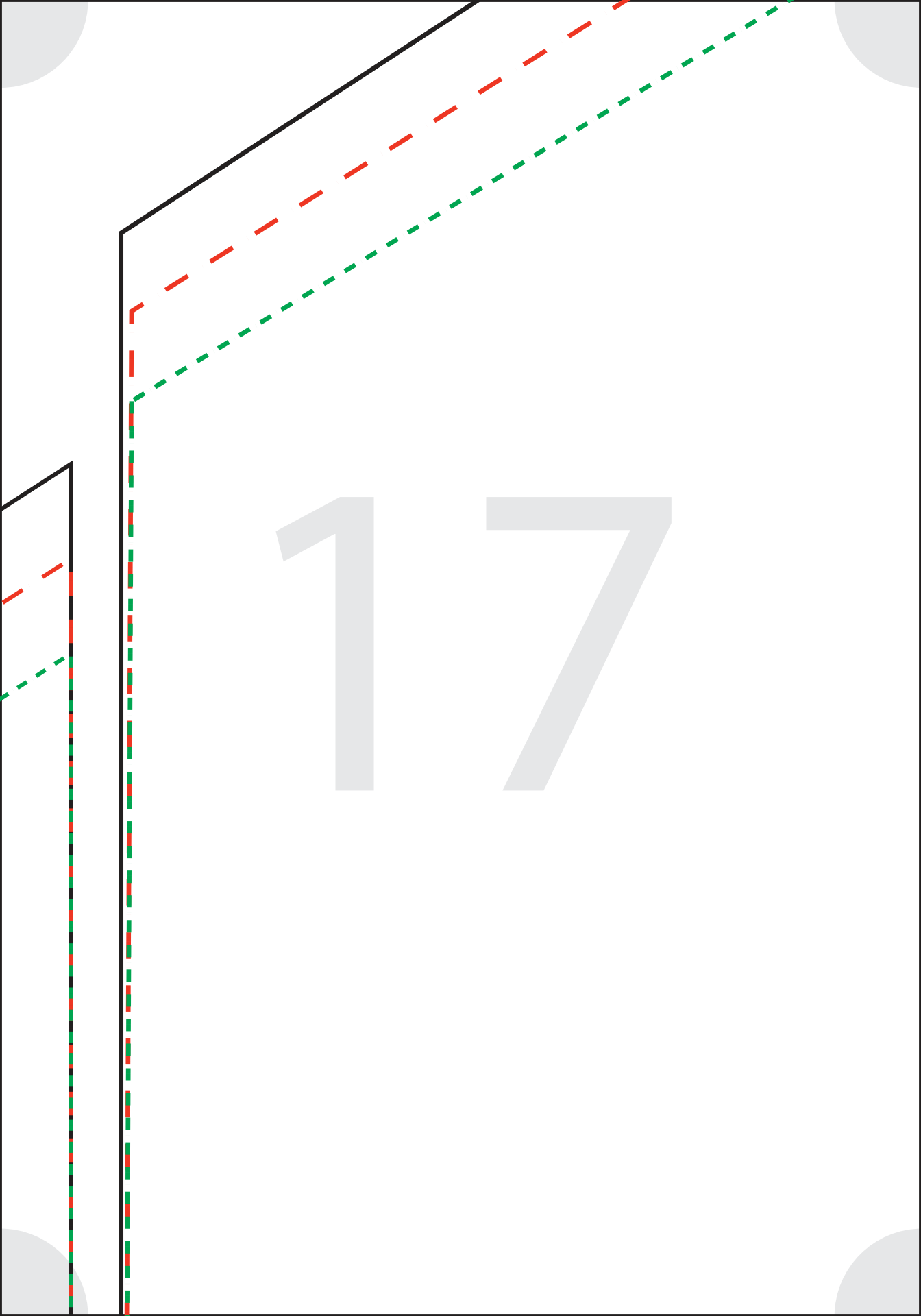

17

18



19

The page features four light gray quarter-circle decorative elements in the corners. A solid black line runs along the top and left edges. A red dashed line and a green dashed line are positioned below the black line, starting from the top edge and extending towards the left edge. The number '20' is centered on the page.

20

21

22

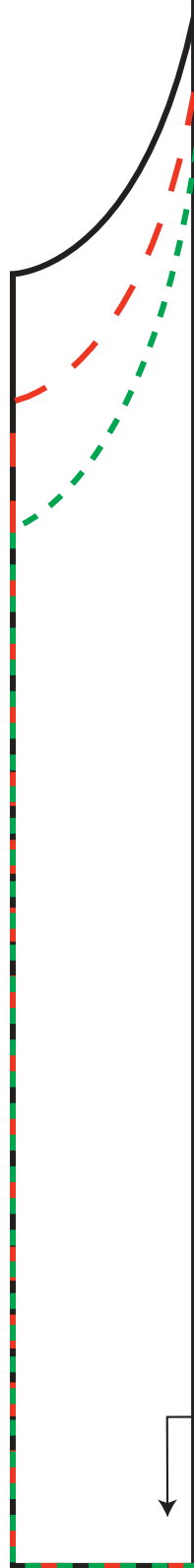



HAPPIESTCAMPER.COM

Flapper Dress FOLD Flares Tier 1 Cut 2 on Fold

3/8" seam allowance already included



HAPPIESTCAMPER.COM

Flapper Dress

FOLD Flares Tier 2

Cut 2 on Fold

3/8" seam allowance already included



25

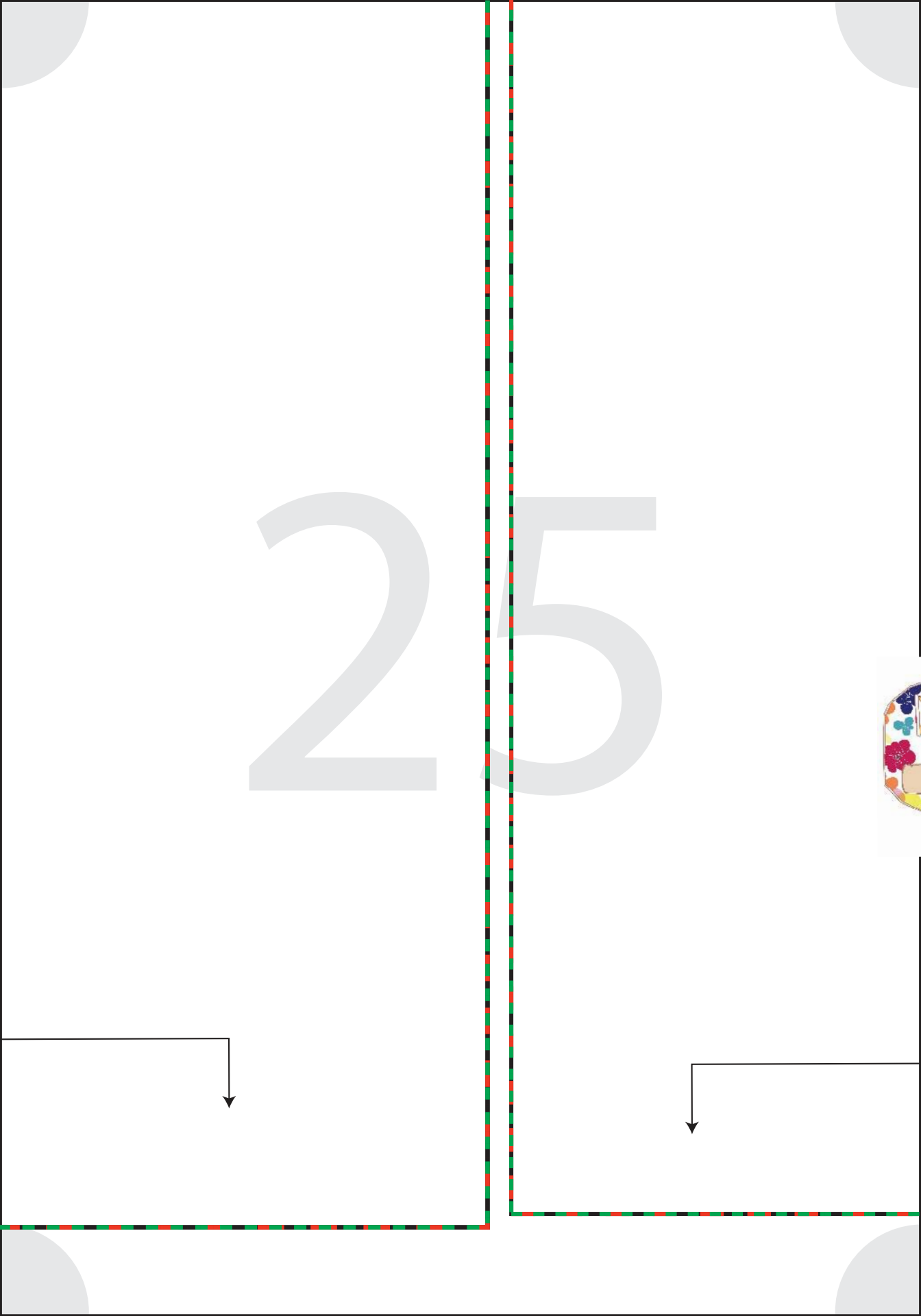
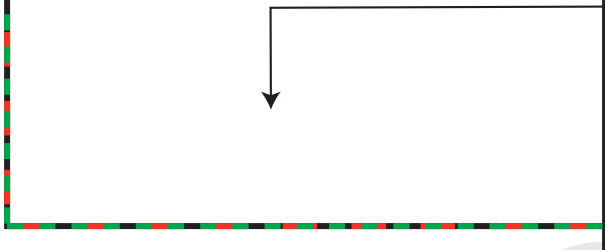



HAPPIESTCAMPER.COM

Flapper Dress

FOLD Flares Tier 3

Cut 2 on Fold

3/8" seam allowance already included

46

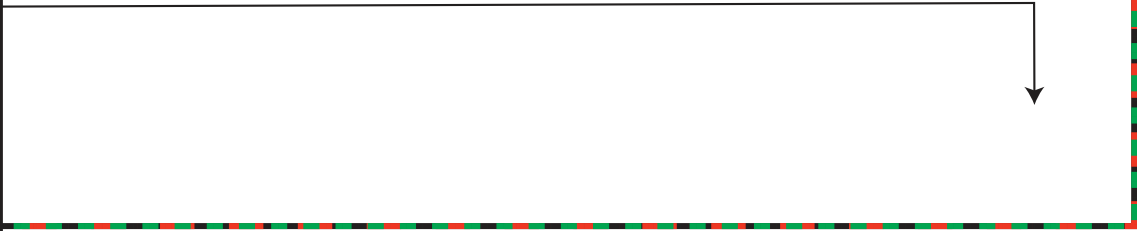



HAPPIESTCAMP.COM

Flapper Dress

FOLD Flares Tier 4

Cut 2 on Fold

3/8" seam allowance already included



28

